

Echo 40F USER

Intel® Core™ i7/ i5/ i3 (Broadwell-U) Slim Embedded System
High Performance, Rugged, Extended Temp, Power Protection

Manual

Record of Revision

Version	Date	Page	Description	Remark
0.10	09/25/2015	All	Preliminary Release	
1.00	10/16/2015		Official Release	

Disclaimer

This manual is released by Wälchli Systems for reference purpose only. All product offerings and specifications are subject to change without prior notice. It does not represent commitment of Wälchli Systems. Wälchli Systems shall not be liable for direct, indirect, special, incidental, or consequential damages arising out of the use of the product or documentation, nor for any infringements upon the rights of third parties, which may result from such use.

Declaration of Conformity

- FCC** This equipment has been tested and found to comply with the limits for a Class A digital device, pursuant to part 15 of the FCC Rules. These limits are designed to provide reasonable protection against harmful interference when the equipment is operated in a commercial environment. This equipment generates, uses, and can radiate radio frequency energy and, if not installed and used in accordance with the instruction manual, may cause harmful interference to radio communications. Operation of this equipment in a residential area is likely to cause harmful interference in which case the user will be required to correct the interference at his own expense.
- CE** The product (s) described in this manual complies with all applicable European Union (CE) directives if it has a CE marking. For computer systems to remain CE compliant, only CE-compliant parts may be used. Maintaining CE compliance also requires proper cable and cabling techniques.

Copyright and Trademarks

This document contains proprietary information protected by copyright. No part of this publication may be reproduced in any form or by any means, electric, photocopying, recording or otherwise, without prior written authorization by Wälchli Systems AG. The rights of all the brand names, product names and trademarks belong to their respective owners.

Order Information

Part Number	Description
E&Q-40F-PoER	Echo-40F- Slim Embedded System, Intel® Core™ i7-5650U Processor (Broadwell-U), 6 GbE LAN with 4 PoE+, 2 Front-access SSD Tray, 4 COM, 6 USB, Isolated DIO
Echo-40F-PoER350U	Echo-40F- Slim Embedded System, Intel® Core™ i5-5350U Processor (Broadwell-U), 6 GbE LAN with 4 PoE+, 2 Front-access SSD Tray, 4 COM, 6 USB, Isolated DIO
Echo-40F-PoE650U	Echo-40F- Slim Embedded System, Intel® Core™ i7-5650U Processor (Broadwell-U), 6 GbE LAN with 4 PoE+, 4 COM, 6 USB, Isolated DIO
Echo-40F-PoE350U	Echo-40F- Slim Embedded System, Intel® Core™ i5-5350U Processor (Broadwell-U), 6 GbE LAN with 4 PoE+, 4 COM, 6 USB, Isolated DIO
Echo-40F-2G650U	Echo-40F- Slim Embedded System, Intel® Core™ i7-5650U Processor (Broadwell-U), 2 GbE LAN, 4 COM, 6 USB, 16 DIO
Echo-40F-2G350U	Echo-40F- Slim Embedded System, Intel® Core™ i5-5350U Processor (Broadwell-U), 2 GbE LAN, 4 COM, 6 USB, 16 DIO
Echo-40F-2R650U	Echo-40F- Slim Embedded System, Intel® Core™ i7-5650U Processor (Broadwell-U), 2 GbE LAN, 2 Front-access SSD Tray, 4 COM, 6 USB, 16 DIO
Echo-40F-2R350U	Echo-40F- Slim Embedded System, Intel® Core™ i5-5350U Processor (Broadwell-U), 2 GbE LAN, 2 Front-access SSD Tray, 4 COM, 6 USB, 16 DIO

Optional Accessories

Part Number	Description
DDR3L4GW XXXXXXXXXX	DDR3L 4GB 1333/1066 MHz RAM, Wide Temperature -40°C to +85°C
DDR3L8G	Certified DDR3L-1600 8G RAM
DDR3L4G	Certified DDR3L-1600 4G RAM
PWA-120W	120W, 24V, 90VAC to 264VAC Power Adapter with 3-pin Terminal Block
PWA-120WM4P	120W, 24V, 90VAC to 264VAC Power Adaptor with 4-pin Mini-DIN Connector
PWA-160W-WT	160W, 24V, 85VAC to 264VAC Power Adaptor with 3-pin Terminal Block, Wide Temperature -30°C to +70°C
3G Module	Mini PCIe 3G/GPS Module with Antenna
4G Module	Mini PCIe 4G/GPS Module with Antenna
WiFi Module	Mini PCIe WiFi Module with Antenna
WiFi & Bluetooth Module	Intel® Mini PCIe WiFi & Bluetooth Module with Antenna
VESA Mount	VESA Mounting Kit
DIN-RAIL	DIN Rail Kit
TMBK-20P-100	Terminal Block 20-pin to SCSI Cable, 100cm
TMBK-20P-500	Terminal Block 20-pin to SCSI Cable, 500cm
TMB-SCSI-20P	Terminal Board with One 20-pin SCSI Connector and DIN-Rail Mounting

Table of Contents

CHAPTER 1	GENERAL INTRODUCTION	1
1.1	Overview	1
1.2	Features	1
1.3	Product Specification	2
1.3.1	Specifications of Echo-40F-PoER	
1.3.2	Specifications of Echo-40F-PoE	
1.3.3	Specifications of Echo-40F-2G	
1.3.4	Specifications of Echo-40F-2R	
1.4	Supported CPU List	10
1.5	Mechanical Dimensions	11
1.5.1	Dimensions of Echo-40F-PoER	
1.5.2	Dimensions of Echo-40F-PoE	
1.5.1	Dimensions of Echo-40F-2G	
1.5.2	Dimensions of Echo-40F-2R	
CHAPTER 2	GETTING TO KNOW YOUR Echo-40F	13
2.1	Packing List	13
2.2	Front Panel I/O Functions	13
2.3	Rear Panel I/O and Functions	19
2.4	Main Board Expansion Connectors	24
2.5	Main Board Jumper Settings	35
2.6	Ignition Control	39
CHAPTER 3	SYSTEM SETUP	42
3.1	How to Open Your Echo-40F	42
3.1.1	Echo-40F-PoE/ Echo-40F-2G	42
3.1.2	Echo-40F-PoER/ Echo-40F-2R	44
3.2	Installing DDR3L SO-DIMM Modules	46

3.3	Installing Mini PCIe Cards	47
3.4	Installing Antenna Cable	48
3.5	Installing CFast Card and SIM Card	50
3.6	Installing SSD/HDD	52
3.6.1	Echo-40F-PoE/ Echo-40F-2G	52
3.6.2	Echo-40F-PoER/ Echo-40F-2R	55
3.7	Mounting Echo-40F	57
CHAPTER 4	BIOS AND DRIVER SETTING	58
4.1	BIOS Settings	58
4.2	Main Menu	59
4.3	Advanced Function	60
4.4	Chipset Function	68
4.5	Boot Function	69
APPENDIX A :	ISOLATED DIO GUIDE	70
APPENDIX B :	GPIO and WDT Functions	73
APPENDIX C :	Power Consumption	74

1

GENERAL INTRODUCTION

1.1 Overview

Echo-40F Series Slim Embedded System is a new generation compact integrated embedded engine in the market. Powered by leading-edge technology, 5th generation Intel® Core™ i7/ i5/ i3 U-Series SoC (Broadwell-U) engine, dual DDR3L 1333/ 1600 MHz SO-DIMMs, up to 16GB memory. Advanced Intel® HD Graphics 6000 supports DVI-D and dual DisplayPort display interface, independent 4K displays with up to 20% enhanced graphics performance than former generation.

Featured with 2 front-access 2.5" SSD/ HDD trays, 6 Gigabit LAN ports with 4 IEEE 802.3at PoE⁺ ports, 2 Mini PCIe sockets for PCIe/ USB/ External SIM Card/ mSATA, 2 External SIM Card sockets support 3G/ 4G/ LTE/ WiFi/ GPRS/ UMTS, 1 External CFast socket, 2 USB 3.0, 4 USB 2.0, 16 Isolated DIO, 6V to 36V wide range power input with up to 80V smart surge protection, 16-mode configurable ignition power control, fanless design and -25°C to 70°C operating temperature, just integrated in a 1.9"-height chassis, Echo-40F is ready to customize for your requirements.

Echo-40F Series Slim Embedded System delivers outstanding performance, compact integration, smart protection functions and trusted rugged reliability for your machine vision, intelligent automation, Intelligent Transportation System (ITS), in-vehicle information system, logistic system, Industry 4.0 and any Internet of Thing (IoT) applications.

1.2 Features

- 5th generation Intel® Core™ i7/ i5/ i3 U-Series Processor (Broadwell-U)
- Fanless, -25°C to 70°C Operating Temperature
- Supports 4K Ultra HD Resolution, up to 3 independent displays
- 6 Gigabit LAN with 4 IEEE 802.3at PoE⁺
- 16 Isolated DIO (8 DI, 8 DO)
- 2 Mini PCIe for 3G/ 4G/ LTE/ WiFi/ GPRS/ UMTS
- 2 External SIM Card Socket
- 2 Front-access 2.5" HDD/ SSD Tray
- 4 COM RS-232/ 422/ 485, 2 USB 3.0, 4 USB 2.0
- 6V to 36V DC-in with 80V Surge Protection
- Configurable Ignition Power Control

1.3 Product Specification

1.3.1 Specifications of Echo-40F-PoER

System	
Processor	5 th Generation Intel® Core™ i7/ i5/ i3 U-Series Processor (Broadwell-U)
Chipset	Intel® SoC (Broadwell-U)
BIOS	AMI
SIO	IT8786E
Memory	<ul style="list-style-type: none"> • DDR3L 1333/ 1600 MHz SO-DIMM, up to 16GB • 2 204-pin SO-DIMM Socket
I/O Interface	
Serial	4 COM RS-232/ 422/ 485
USB	<ul style="list-style-type: none"> • 2 USB 3.0 (External) • 4 USB 2.0 (3 External, 1 Internal)
Isolated DIO	16 Isolated DIO : 8 DI, 8 DO
LED	Power, HDD, PoE
SIM Card	2 SIM Card Socket (External)
Expansion	
Mini PCIe	2 Mini PCIe Socket : <ul style="list-style-type: none"> • 1 Mini PCIe for PCIe/ USB/ External SIM Card • 1 Mini PCIe for PCIe/ USB/ External SIM Card/ mSATA
Graphics	
Chipset	Intel® HD 6000, up to 3 independent displays
Interface	<ul style="list-style-type: none"> • DVI-D : Up to 1920 x 1080 @ 60Hz • DisplayPort 1 : Up to 3840 x 2160 @ 60Hz • DisplayPort 2 : Up to 3840 x 2160 @ 60Hz
Storage	
SATA	2 SATA III (6Gbps)
mSATA	1 SATA III (Mini PCIe Type, 6Gbps)
Storage Device	<ul style="list-style-type: none"> • 1 CFast Socket, Push-in/ Push-out Ejector • 2 Front-access SSD/ HDD Tray
Audio	
Audio Codec	Realtek ALC892, 5.1 Channel HD Audio
Audio Interface	1 Mic-in, 1 Line-out
Ethernet	
LAN 1	Intel® I218 Gigabit LAN
LAN 2	Intel® I210 Gigabit LAN

PoE	
LAN 3	Gigabit IEEE 802.3at (25.5W/48V) PoE ⁺ by Intel [®] I210
LAN 4	Gigabit IEEE 802.3at (25.5W/48V) PoE ⁺ by Intel [®] I210
LAN 5	Gigabit IEEE 802.3at (25.5W/48V) PoE ⁺ by Intel [®] I210
LAN 6	Gigabit IEEE 802.3at (25.5W/48V) PoE ⁺ by Intel [®] I210
Power	
Power Input	6V to 36V, DC-in
Power Interface	<ul style="list-style-type: none"> • 3-pin Terminal Block : V+, V-, IGN, Frame Ground • Mini-DIN 4-pin
Ignition Control	16 Mode (Internal)
Remote Switch	3-pin Terminal Block : On, Off, IGN
Surge Protection	Up to 80V/1ms Transient Power
Others	
TPM	Optional Infineon SLB9665 supports TPM 2.0, LPC Interface
Watchdog Timer	Reset : 1 to 255 sec./min. per step
Smart Management	Wake on LAN, PXE supported
HW Monitor	Monitoring temperature, voltages. Auto throttling control when CPU overheats.
Software Support	
OS	Windows 10, Windows 8.1, Windows 7, Linux
Mechanical	
Dimensions (WxDxH)	257mm x 141mm x 48mm (10.1" x 5.6" x 1.9")
Weight	2.1 kg (4.6 lb)
Mounting	<ul style="list-style-type: none"> • Wallmount by mounting bracket • DIN Rail Mount
Environment	
Operating Temperature	-25°C to 70°C (-13°F to 158°F)
Storage Temperature	-40°C to 85°C (-40°F to 185°F)
Humidity	5% to 95% humidity, non-condensing
Relative Humidity	95% at 70°C
Shock	<ul style="list-style-type: none"> • IEC 60068-2-27 • SSD : 50G @ wallmount, Half-sine, 11ms
Vibration	<ul style="list-style-type: none"> • IEC 60068-2-64 • SSD : 5Grms, 5Hz to 500Hz, 3 Axis
EMC	CE, FCC, EN 50155, EN 50121-3-2

1.3.2 Specifications of Echo-40F-PoE

System	
Processor	5 th Generation Intel® Core™ i7/ i5/ i3 U-Series Processor (Broadwell-U)
Chipset	Intel® SoC (Broadwell-U)
BIOS	AMI
SIO	IT8786E
Memory	<ul style="list-style-type: none"> • DDR3L 1333/ 1600 MHz SO-DIMM, up to 16GB • 2 204-pin SO-DIMM Socket
I/O Interface	
Serial	4 COM RS-232/ 422/ 485
USB	<ul style="list-style-type: none"> • 2 USB 3.0 (External) • 4 USB 2.0 (3 External, 1 Internal)
Isolated DIO	16 Isolated DIO : 8 DI, 8 DO
LED	Power, HDD, PoE
SIM Card	2 SIM Card Socket (External)
Expansion	
Mini PCIe	2 Mini PCIe Socket : <ul style="list-style-type: none"> • 1 Mini PCIe for PCIe/ USB/ External SIM Card • 1 Mini PCIe for PCIe/ USB/ External SIM Card/ mSATA
Graphics	
Chipset	Intel® HD 6000, up to 3 independent displays
Interface	<ul style="list-style-type: none"> • DVI-D : Up to 1920 x 1080 @ 60Hz • DisplayPort 1 : Up to 3840 x 2160 @ 60Hz • DisplayPort 2 : Up to 3840 x 2160 @ 60Hz
Storage	
SATA	2 SATA III (6Gbps)
mSATA	1 SATA III (Mini PCIe Type, 6Gbps)
Storage Device	1 CFast Socket, Push-in/ Push-out Ejector
Audio	
Audio Codec	Realtek ALC892, 5.1 Channel HD Audio
Audio Interface	1 Mic-in, 1 Line-out
Ethernet	
LAN 1	Intel® I218 Gigabit LAN
LAN 2	Intel® I210 Gigabit LAN

PoE	
LAN 3	Gigabit IEEE 802.3at (25.5W/48V) PoE ⁺ by Intel® I210
LAN 4	Gigabit IEEE 802.3at (25.5W/48V) PoE ⁺ by Intel® I210
LAN 5	Gigabit IEEE 802.3at (25.5W/48V) PoE ⁺ by Intel® I210
LAN 6	Gigabit IEEE 802.3at (25.5W/48V) PoE ⁺ by Intel® I210
Power	
Power Input	6V to 36V, DC-in
Power Interface	<ul style="list-style-type: none"> • 3-pin Terminal Block : V+, V-, Frame Ground • Mini-DIN 4-pin
Ignition Control	16 Mode (Internal)
Remote Switch	3-pin Terminal Block : On, Off, IGN
Surge Protection	Up to 80V/1ms Transient Power
Others	
TPM	Optional Infineon SLB9665 supports TPM 2.0, LPC Interface
Watchdog Timer	Reset : 1 to 255 sec./min. per step
Smart Management	Wake on LAN, PXE supported
HW Monitor	Monitoring temperature, voltages. Auto throttling control when CPU overheats.
Software Support	
OS	Windows 10, Windows 8.1, Windows 7, Linux
Mechanical	
Dimensions (WxDxH)	257mm x 141mm x 48mm (10.1" x 5.6" x 1.9")
Weight	2.1 kg (4.6 lb)
Mounting	<ul style="list-style-type: none"> • Wallmount by mounting bracket • DIN Rail Mount
Environment	
Operating Temperature	-25°C to 70°C (-13°F to 158°F)
Storage Temperature	-40°C to 85°C (-40°F to 185°F)
Humidity	5% to 95% humidity, non-condensing
Relative Humidity	95% at 70°C
Shock	<ul style="list-style-type: none"> • IEC 60068-2-27 • SSD : 50G @ wallmount, Half-sine, 11ms
Vibration	<ul style="list-style-type: none"> • IEC 60068-2-64 • SSD : 5Grms, 5Hz to 500Hz, 3 Axis
EMC	CE, FCC, EN 50155, EN 50121-3-2

1.3.3 Specifications of Echo-40F-2G

System	
Processor	5 th Generation Intel® Core™ i7/ i5/ i3 U-Series Processor (Broadwell-U)
Chipset	Intel® SoC (Broadwell-U)
BIOS	AMI
SIO	IT8786E
Memory	<ul style="list-style-type: none"> • DDR3L 1333/ 1600 MHz SO-DIMM, up to 16GB • 2 204-pin SO-DIMM Socket
I/O Interface	
Serial	4 COM RS-232/ 422/ 485
USB	<ul style="list-style-type: none"> • 2 USB 3.0 (External) • 4 USB 2.0 (3 External, 1 Internal)
DIO	16 DIO : 8 DI, 8 DO
LED	Power, HDD
SIM Card	2 SIM Card Socket (External)
Expansion	
Mini PCIe	2 Mini PCIe Socket : <ul style="list-style-type: none"> • 1 Mini PCIe for PCIe/ USB/ External SIM Card • 1 Mini PCIe for PCIe/ USB/ External SIM Card/ mSATA
Graphics	
Chipset	Intel® HD 6000, up to 3 independent displays
Interface	<ul style="list-style-type: none"> • DVI-D : Up to 1920 x 1080 @ 60Hz • DisplayPort 1 : Up to 3840 x 2160 @ 60Hz • DisplayPort 2 : Up to 3840 x 2160 @ 60Hz
Storage	
SATA	2 SATA III (6Gbps)
mSATA	1 SATA III (Mini PCIe Type, 6Gbps)
Storage Device	1 CFAST Socket, Push-in/ Push-out Ejector
Audio	
Audio Codec	Realtek ALC892, 5.1 Channel HD Audio
Audio Interface	1 Mic-in, 1 Line-out
Ethernet	
LAN 1	Intel® I218 Gigabit LAN
LAN 2	Intel® I210 Gigabit LAN

Power	
Power Input	6V to 36V, DC-in
Power Interface	<ul style="list-style-type: none"> • 3-pin Terminal Block : V+, V-, Frame Ground • Mini-DIN 4-pin
Ignition Control	16 Mode (Internal)
Remote Switch	3-pin Terminal Block : On, Off, IGN
Surge Protection	Up to 80V/1ms Transient Power
Others	
TPM	Optional Infineon SLB9665 supports TPM 2.0, LPC Interface
Watchdog Timer	Reset : 1 to 255 sec./min. per step
Smart Management	Wake on LAN, PXE supported
HW Monitor	Monitoring temperature, voltages. Auto throttling control when CPU overheats.
Software Support	
OS	Windows 10, Windows 8.1, Windows 7, Linux
Mechanical	
Dimensions (WxDxH)	257mm x 141mm x 48mm (10.1" x 5.6" x 1.9")
Weight	2.1 kg (4.6 lb)
Mounting	<ul style="list-style-type: none"> • Wallmount by mounting bracket • DIN Rail Mount
Environment	
Operating Temperature	-25°C to 70°C (-13°F to 158°F)
Storage Temperature	-40°C to 85°C (-40°F to 185°F)
Humidity	5% to 95% humidity, non-condensing
Relative Humidity	95% at 70°C
Shock	<ul style="list-style-type: none"> • IEC 60068-2-27 • SSD : 50G @ wallmount, Half-sine, 11ms
Vibration	<ul style="list-style-type: none"> • IEC 60068-2-64 • SSD : 5Grms, 5Hz to 500Hz, 3 Axis
EMC	CE, FCC, EN 50155, EN 50121-3-2

1.3.4 Specifications of Echo-40F-2R

System	
Processor	5 th Generation Intel® Core™ i7/ i5/ i3 U-Series Processor (Broadwell-U)
Chipset	Intel® SoC (Broadwell-U)
BIOS	AMI
SIO	IT8786E
Memory	<ul style="list-style-type: none"> • DDR3L 1333/ 1600 MHz SO-DIMM, up to 16GB • 2 204-pin SO-DIMM Socket
I/O Interface	
Serial	4 COM RS-232/ 422/ 485
USB	<ul style="list-style-type: none"> • 2 USB 3.0 (External) • 4 USB 2.0 (3 External, 1 Internal)
DIO	16 DIO : 8 DI, 8 DO
LED	Power, HDD
SIM Card	2 SIM Card Socket (External)
Expansion	
Mini PCIe	2 Mini PCIe Socket : <ul style="list-style-type: none"> • 1 Mini PCIe for PCIe/ USB/ External SIM Card • 1 Mini PCIe for PCIe/ USB/ External SIM Card/ mSATA
Graphics	
Chipset	Intel® HD 6000, up to 3 independent displays
Interface	<ul style="list-style-type: none"> • DVI-D : Up to 1920 x 1080 @ 60Hz • DisplayPort 1 : Up to 3840 x 2160 @ 60Hz • DisplayPort 2 : Up to 3840 x 2160 @ 60Hz
Storage	
SATA	2 SATA III (6Gbps)
mSATA	1 SATA III (Mini PCIe Type, 6Gbps)
Storage Device	<ul style="list-style-type: none"> • 1 CFast Socket, Push-in/ Push-out Ejector • 2 Front-access SSD/ HDD Tray
Audio	
Audio Codec	Realtek ALC892, 5.1 Channel HD Audio
Audio Interface	1 Mic-in, 1 Line-out
Ethernet	
LAN 1	Intel® I218 Gigabit LAN
LAN 2	Intel® I210 Gigabit LAN

Power	
Power Input	6V to 36V, DC-in
Power Interface	<ul style="list-style-type: none"> • 3-pin Terminal Block : V+, V-, IGN, Frame Ground • Mini-DIN 4-pin
Ignition Control	16 Mode (Internal)
Remote Switch	3-pin Terminal Block : On, Off, IGN
Surge Protection	Up to 80V/1ms Transient Power
Others	
TPM	Optional Infineon SLB9665 supports TPM 2.0, LPC Interface
Watchdog Timer	Reset : 1 to 255 sec./min. per step
Smart Management	Wake on LAN, PXE supported
HW Monitor	Monitoring temperature, voltages. Auto throttling control when CPU overheats.
Software Support	
OS	Windows 10, Windows 8.1, Windows 7, Linux
Mechanical	
Dimensions (WxDxH)	257mm x 141mm x 48mm (10.1" x 5.6" x 1.9")
Weight	2.1 kg (4.6 lb)
Mounting	<ul style="list-style-type: none"> • Wallmount by mounting bracket • DIN Rail Mount
Environment	
Operating Temperature	-25°C to 70°C (-13°F to 158°F)
Storage Temperature	-40°C to 85°C (-40°F to 185°F)
Humidity	5% to 95% humidity, non-condensing
Relative Humidity	95% at 70°C
Shock	<ul style="list-style-type: none"> • IEC 60068-2-27 • SSD : 50G @ wallmount, Half-sine, 11ms
Vibration	<ul style="list-style-type: none"> • IEC 60068-2-64 • SSD : 5Grms, 5Hz to 500Hz, 3 Axis
EMC	CE, FCC, EN 50155, EN 50121-3-2

1.4 Supported CPU List

CPU Name	TDP	Cache	Max. Frequency	Embedded
i7-5557U	28W	4M	Up to 3.40 GHz	
i7-5650U	15W	4M	Up to 3.20 GHz	Yes
i7-5600U	15W	4M	Up to 3.20 GHz	
i7-5550U	15W	4M	Up to 3.00 GHz	
i7-5500U	15W	4M	Up to 3.00 GHz	
i5-5287U	28W	3M	Up to 3.30 GHz	
i5-5257U	28W	3M	Up to 3.10 GHz	
i5-5350U	15W	3M	Up to 2.90 GHz	Yes
i5-5300U	15W	3M	Up to 2.90 GHz	
i5-5250U	15W	3M	Up to 2.70 GHz	
i5-5200U	15W	3M	Up to 2.70 GHz	
i3-5157U	28W	3M	Up to 2.50 GHz	
i3-5020U	15W	3M	Up to 2.20 GHz	
i3-5015U	15W	3M	Up to 2.10 GHz	Yes
i3-5010U	15W	3M	Up to 2.10 GHz	
i3-5005U	15W	3M	Up to 2.00 GHz	
Pentium 3805U	15W	2M	Up to 1.90 GHz	
Pentium 3825U	15W	2M	Up to 1.90 GHz	
Celeron 3765U	15W	2M	Up to 1.90 GHz	
Celeron 3755U	15W	2M	Up to 1.70 GHz	Yes
Celeron 3215U	15W	2M	Up to 1.70 GHz	
Celeron 3205U	15W	2M	Up to 1.50 GHz	

1.5 Mechanical Dimensions

1.5.1 Dimensions of Echo-40F-PoER

Unit: mm (inch)

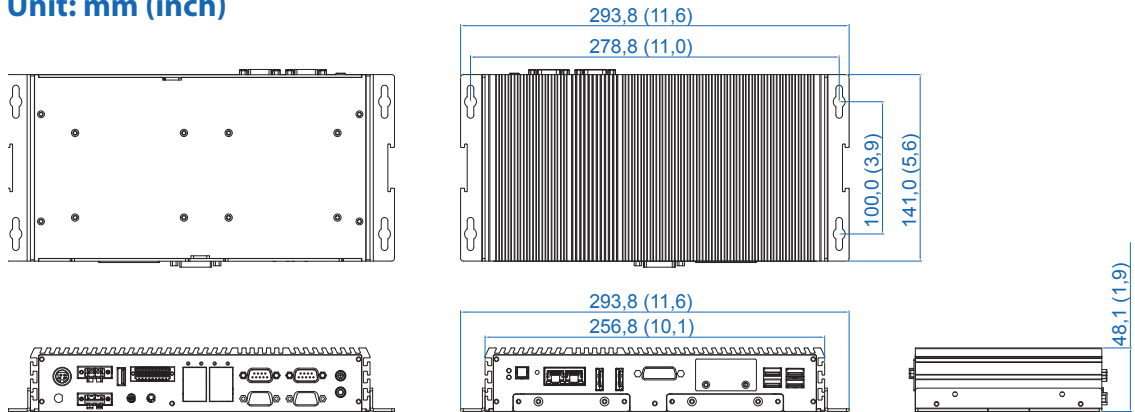

1.5.2 Dimensions of Echo-40F-PoE

Unit: mm (inch)

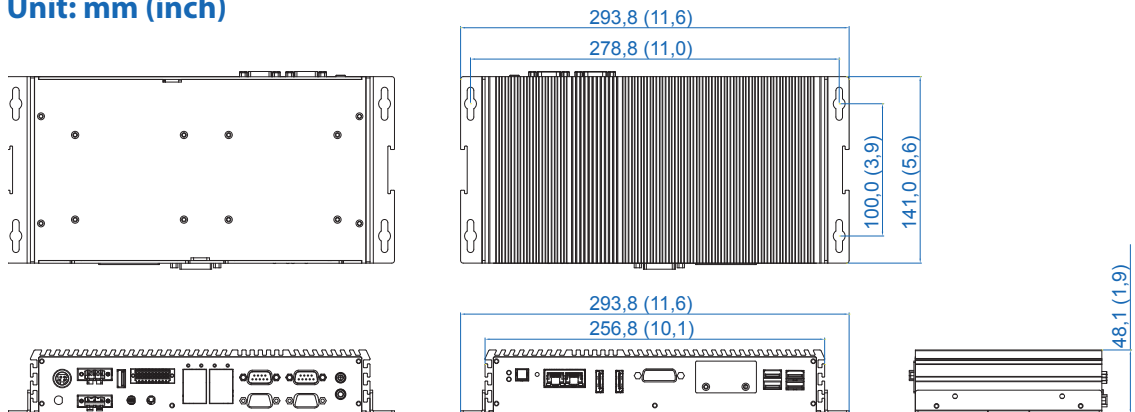

1.5.1 Dimensions of Echo-40F-2G

Unit: mm (inch)

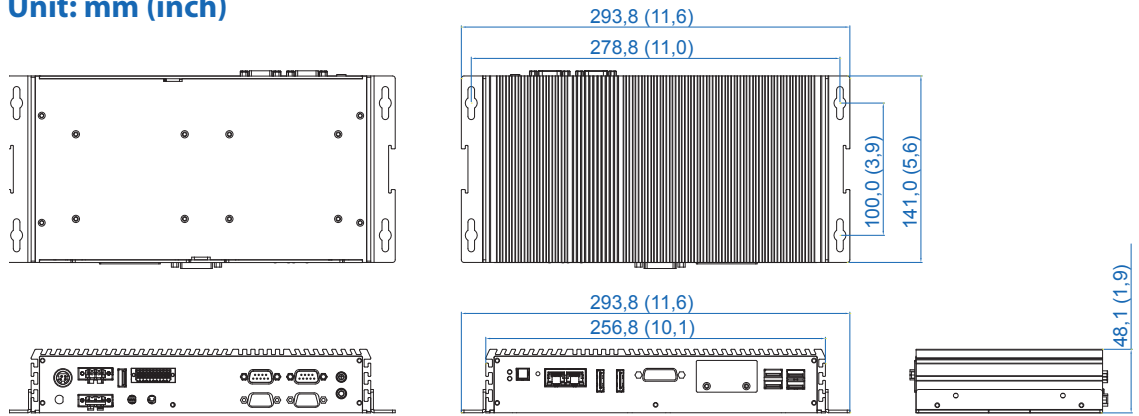

1.5.2 Dimensions of Echo-40F-2R

Unit: mm (inch)

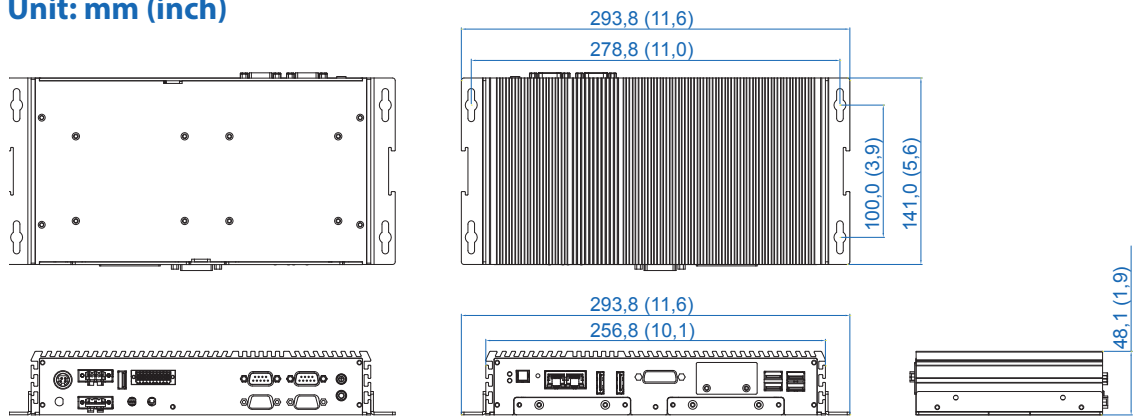

2

GETTING TO KNOW YOUR Echo-40F

2.1 Packing List

Item	Description	Qty
1	Echo-40F Slim Embedded System (According to the configuration you order, the Echo-40F series may contain SSD/HDD and DDR3L SO-DIMM. Please verify these items if necessary.)	1
2	Accessory box, which contains <ul style="list-style-type: none">• Drivers & Utilities DVD• Wall-mounting bracket• KHS#6-32x6 screw for wall-mounting bracket• M2.5x6 screw for Mini PCIe Slot• 3-pin Pluggable terminal block• 20-pin pluggable terminal block• Foot Pad• HDD Tray Key	1 2 4 4 2 1 4 2

2.2 Front Panel I/O Functions

In Echo-40F series family, all I/O connectors are located on front panel and rear panel. Most of the general connections to computer device, such as USB, DVI-D, DisplayPort and any additional storage, are placed on the front panel.

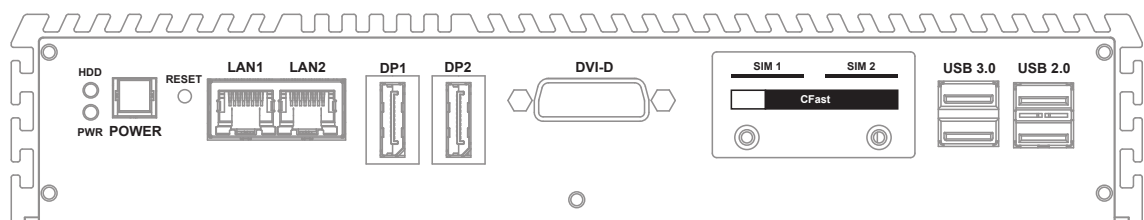

2.2.1 Reset Tact Switch

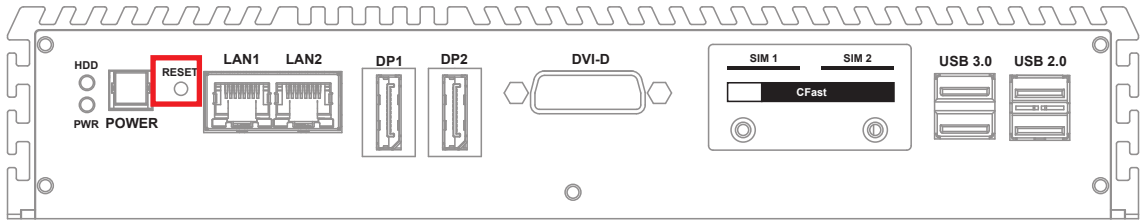

It is a hardware reset switch. Use this switch to reset the system without power off the Echo-40F. Press the Reset Switch for a few seconds, then reset will be enabled.

2.2.2 Power Button

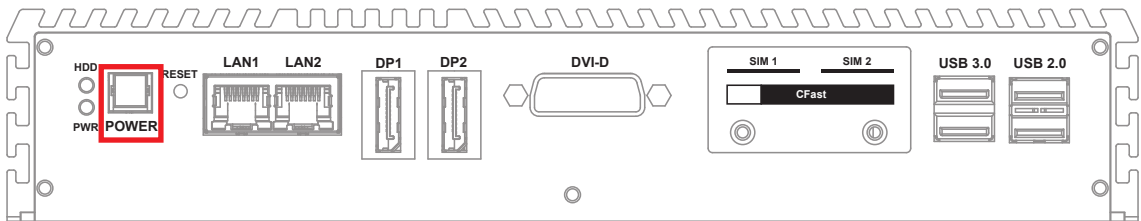

The Power Button is a non-latched switch with dual color LED indication. It indicates power status: S0, S3 and S5. More detail LED indications are listed as follows:

LED Color	Power Status	System Status
Solid Blue	S0	System working
Solid Orange	S3, S5	Suspend to RAM, System off with standby power

To power on Echo-40F, press the power button and then the blue LED is lightened.

To power off Echo-40F, you can either command shutdown by OS operation, or just simply press the power button.

If system error, you can just press the power button for 4 seconds to shut down the machine directly.

Please do note that a 4-second interval between each 2 power-on/ power-off operation is necessary in normal working status. (For example, once turning off the system, you have to wait for 4 seconds to initiate another power-on operation).

2.2.3 CFast Card

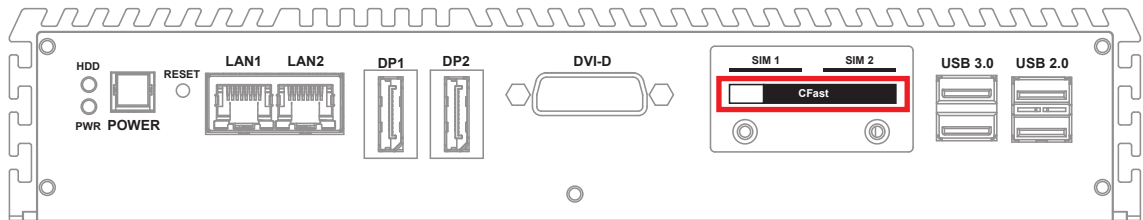

There is a CFast socket on the front panel supporting Type-I/ Type-II Compact Flash card. It is implemented by a SATA II Port from Broadwell-U PCH.

Be sure to disconnect the power source and unscrew the CFast socket cover before installing a CFast card. The Echo-40F does not support the CFast hot swap and PnP (Plug and Play) functions.

It is necessary to remove power source first before inserting or removing the CFast card.

The pinouts of CFast port are listed as follows:

Pin No.	Description	Pin No.	Description
S1	GND	PC6	NC
S2	SATA_TXP	PC7	GND
S3	SATA_TXN	PC8	CFAST_LED
S4	GND	PC9	NC
S5	SATA_RXN	PC10	NC
S6	SATA_RXP	PC11	NC
S7	GND	PC12	NC
PC1	GND	PC13	+3.3V
PC2	GND	PC14	+3.3V
PC3	GND	PC15	GND
PC4	NC	PC16	GND
PC5	NC	PC17	NC

2.2.4 PWR and HDD LED Indicator

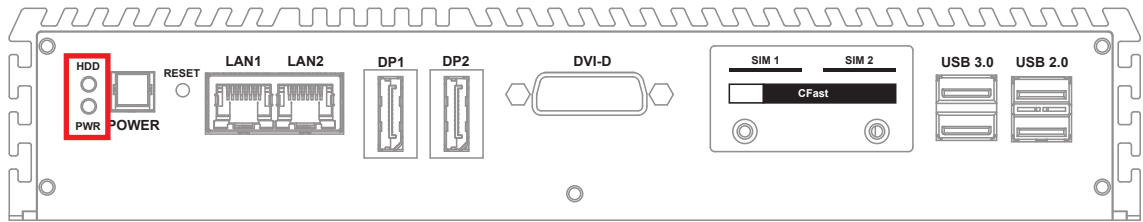

Yellow-HDD LED: A hard disk/ CFast LED. If the LED is on, it indicates that the system's storage is functional. If it is off, it indicates that the system's storage is not functional. If it is flashing, it indicates data access activities.

Green-Power LED: If the LED is solid green, it indicates that the system is powered on.

LED Color	Power Status	System Status
Yellow	HDD/ CFast	<ul style="list-style-type: none"> On/ Off : Storage status, function or not. Twinkling : Data transferring.
Green	Power	System power status (on/ off)

2.2.5 DVI-D Connector

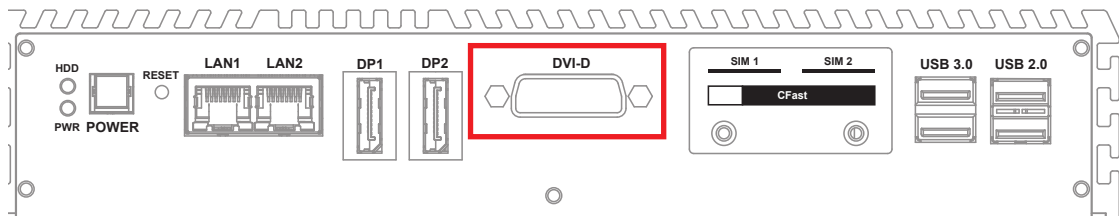

The DVI-D connector on the front panel supports DVI display modes. The DVI output mode supports up to 1920 x 1080 resolutions.

2.2.6 DisplayPort

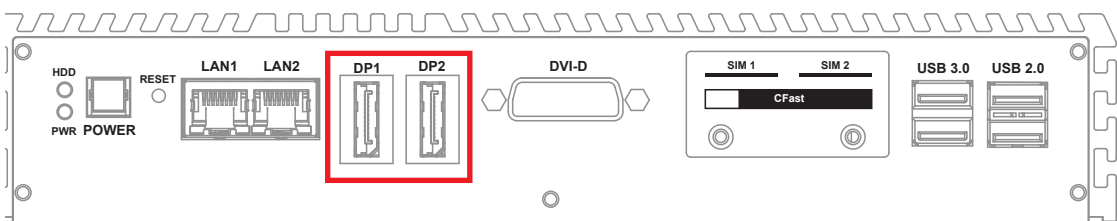

Onboard DisplayPort connection supports up to 3840 x 2160 resolutions at 60Hz. DP1 only supports DisplayPort, it does not support HDMI and DVI function.

2.2.7 External USB

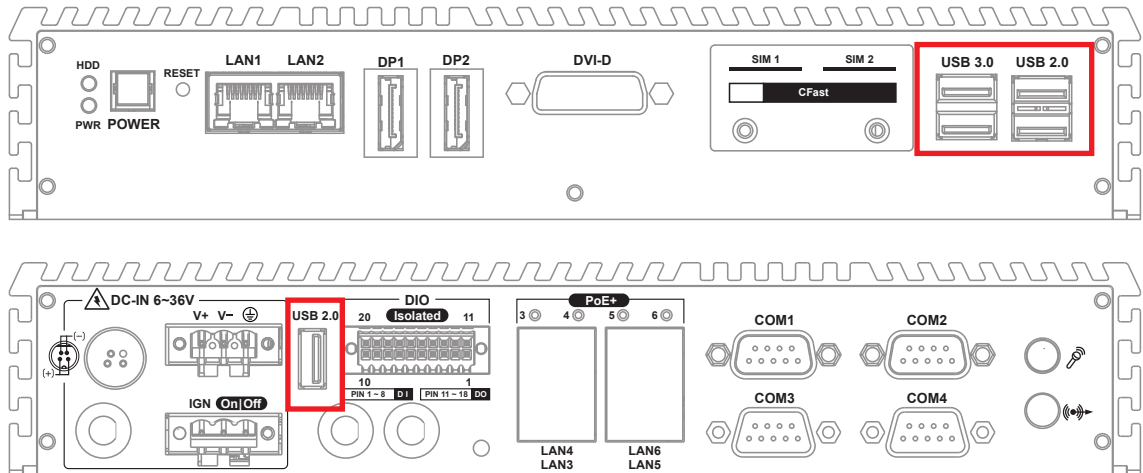

There are 2 USB 3.0 connections available supporting up to 5GB per second data rate in the front side of Echo-40F. They also comply with the requirements of SuperSpeed (SS), High Speed (HS), Full Speed (FS) and Low Speed (LS).

2.2.8 Mini PCIe & SIM Card Comparison Table

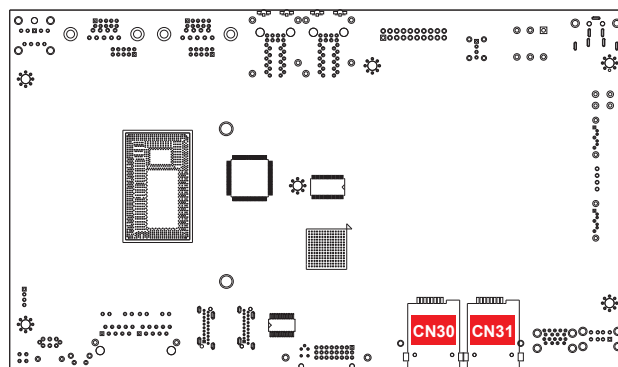
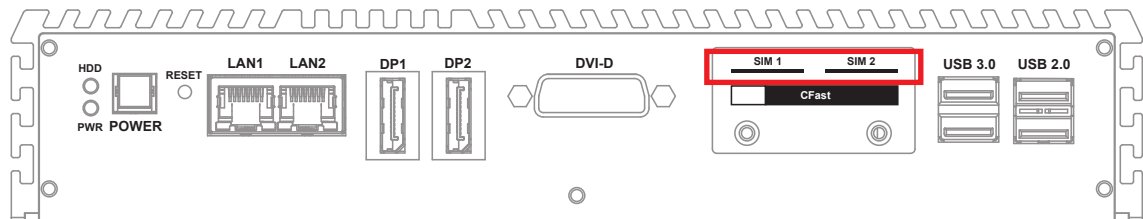

Mini PCIe	SIM
CN18	CN30 (SIM 1)
CN16	CN31 (SIM 2)

Note:

The SIM card sockets do not support hot-plug. Please make sure to unplug the system power before inserting the SIM card(s).

2.2.9 10/ 100/ 1000 Mbps Ethernet Port

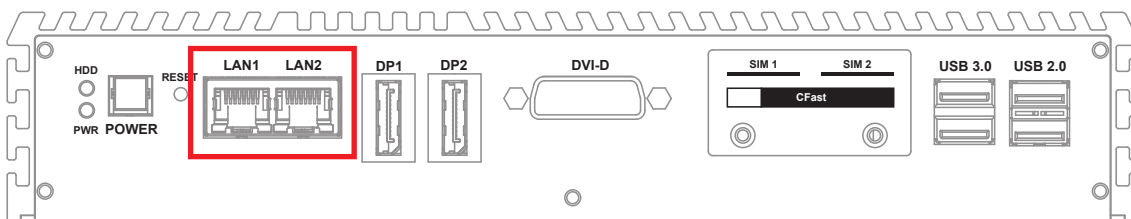

There are 2 8-pin RJ-45 jacks supporting 10/ 100/1000 Mbps Ethernet connections in the front side of Echo-40F. LAN 1 is powered by Intel® 218LM Ethernet engine; LAN 2 is powered by Intel I210 Ethernet engine. When both LAN 1 and LAN 2 work in normal status, basic iAMT function is enabled. Using suitable RJ-45 cable, you can connect Echo-40F system to a computer, or to any other devices with Ethernet connection, for example, a hub or a switch. Moreover, both of LAN 1 and LAN 2 supports Wake on LAN and Pre-boot functions. The pinouts of LAN 1 and LAN 2 are listed as follows:

Pin No.	10/ 100Mbps	1000Mbps
1	E_TX+	MDI0_P
2	E_TX-	MDI0_N
3	E_RX+	MDI1_P
4	----	MDI2_P
5	-----	MDI2_N
6	E_RX-	MDI1_N
7	-----	MDI3_P
8	-----	MDI3_N

Each LAN port is supported by standard RJ-45 connector with LED indicators to present Active/ Link/ Speed status of the connection.

The LED indicator on the right bottom corner lightens in solid green when the cable is properly connected to a 100Mbps Ethernet network; The LED indicator on the right bottom corner lightens in solid orange when the cable is properly connected to a 1000Mbps Ethernet network; The left LED will keep twinkling/ off when Ethernet data packets are being transmitted/ received.

LED	10Mbps	100Mbps	1000Mbps
Right Bottom Led	Off	Solid Green	Solid Orange
Left Bottom Led	Twinkling Yellow	Twinkling Yellow	Twinkling Yellow

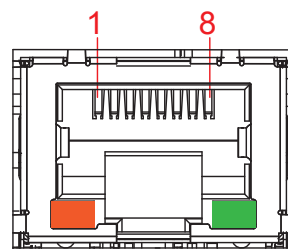

2.3 Rear Panel I/O and Functions

2.3.1 Power Terminal Block

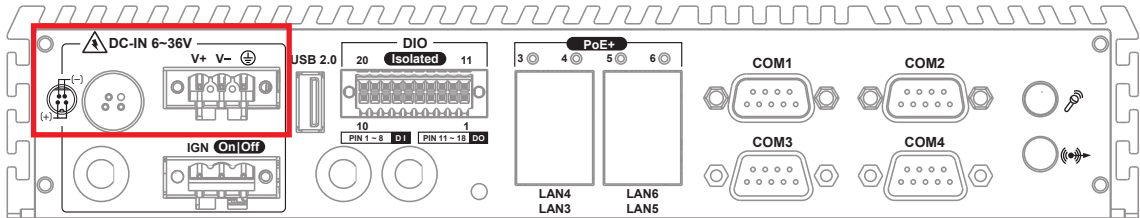

Echo-40F supports 6V to 36V DC power input by terminal block in the rear side. In normal power operation, power LED lightens in solid green. Echo-40F supports up to 80V surge protection.

Pin No.	Definition
1	V+
2	V-
3	Earth GND

2.3.2 Remote Power On/ Off Switch

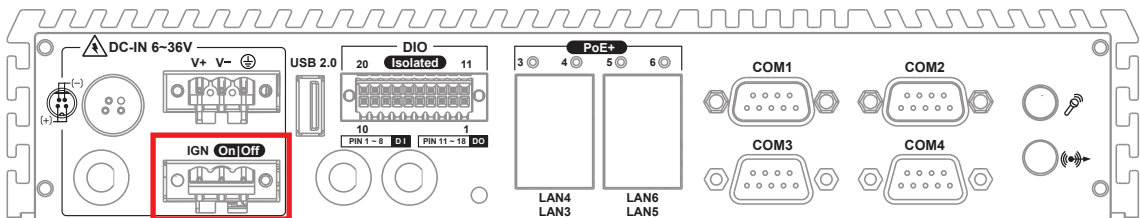

It is a 2-pin power-on or power-off switch through Phoenix Contact terminal block. You could turn on or off the system power by using this contact. This terminal block supports dual function of soft power-on/ power-off (instant off or delay 4 second), and suspend mode.



Pin No.	Definition
1	IGNITION
2	SW+
3	SW-

2.3.3 Isolated DIO

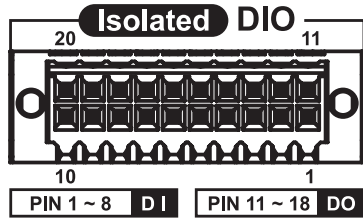
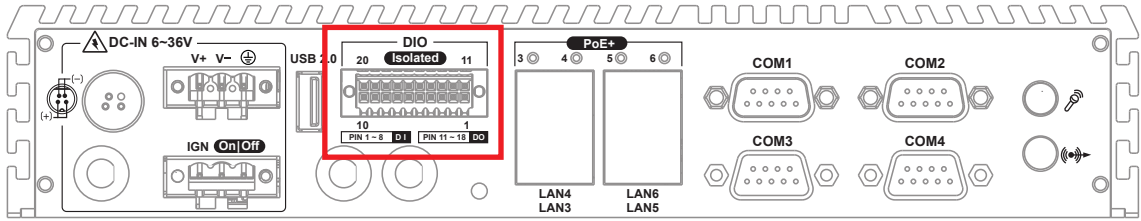

There is a 16-bit DIO (8-bit DI, 8-bit DO) connector in the rear side. Each DIO channel is equipped with a photocoupler for isolated protection. A power buffer device TPD2007F integrated in 8-DO circuit for motors, solenoids, and lamp driver applications. Please refer to [Appendix A](#) for more details.

Pin No.	Definition	Pin No.	Definition
1	INPUT 0	11	OUTPUT 0
2	INPUT 1	12	OUTPUT 1
3	INPUT 2	13	OUTPUT 2
4	INPUT 3	14	OUTPUT 3
5	INPUT 4	15	OUTPUT 4
6	INPUT 5	16	OUTPUT 5
7	INPUT 6	17	OUTPUT 6
8	INPUT 7	18	OUTPUT 7
9	DI_COM	19	DIO_GND
10	DIO_GND	20	External 24~78VDC Input

GPI SINK Mode

Isolated GPI input circuit in SINK mode (NPN) is illustrated as follow :

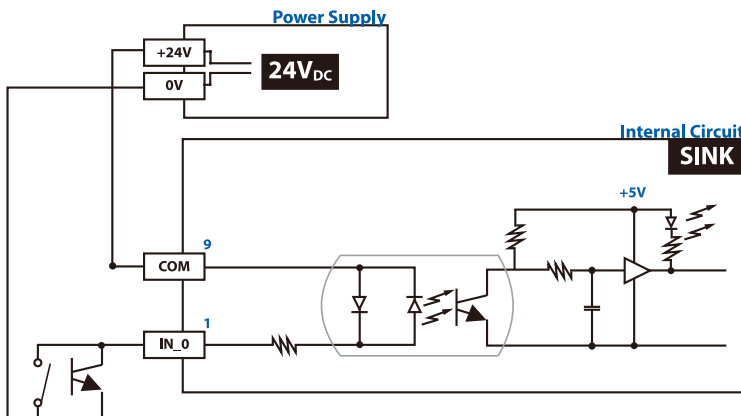

GPI SOURCE Mode

Digital GPI input signal circuit in SOURCE mode (PNP) is illustrated as follow :

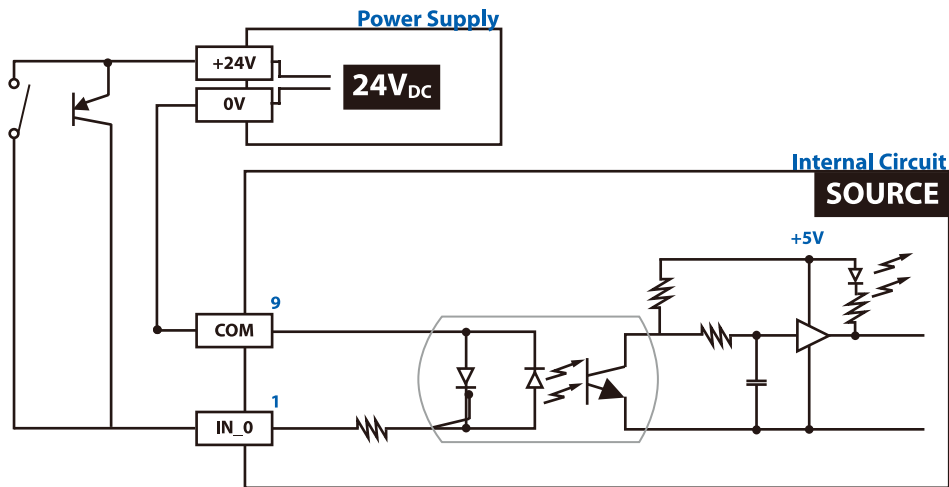

GPO SINK Mode

Digital GPO output circuit in SINK mode (NPN) is illustrated as follow :

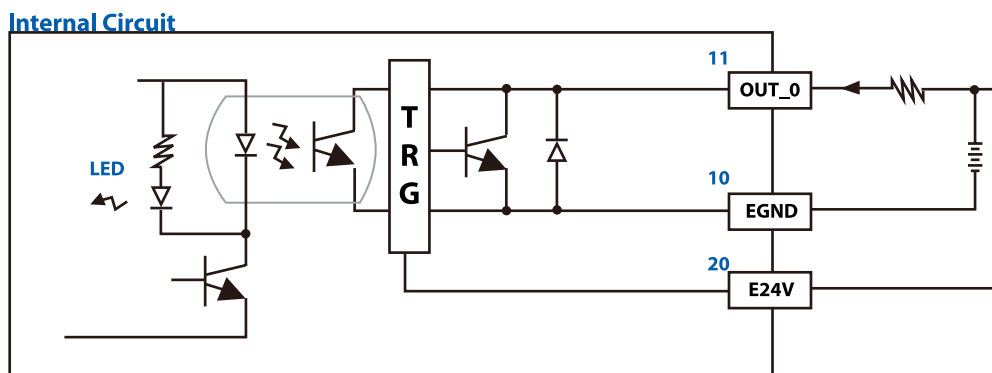

2.3.4 Serial Port COM

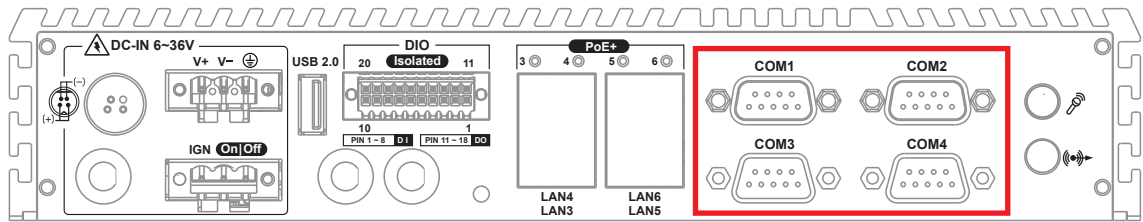

Serial port can be configured for RS-232, RS-422, or RS-485 with auto flow control communication. The default definition is RS-232, if you want to change to RS-422 or RS-485, you can find the setting in BIOS.

BIOS Setting	Function
COM 1 (CN7) /	RS-232
	RS-422 (5-wire)
COM 2 (CN8) /	RS-422 (9-wire)
COM 3 (CN11) /	RS-485
COM 4 (CN12)	RS-485 w/z auto-flow control

The pin assignments are listed in the table as follow :

Serial Port	Pin No.	RS-232	RS-422 (5-wire)	RS-422 (9-wire)	RS-485 (3-wire)
1, 2	1	DCD	TXD-	TXD-	DATA-
	2	RXD	TXD+	TXD+	DATA+
3, 4	3	TXD	RXD+	RXD+	-----
	4	DTR	RXD-	RXD-	-----
	5	GND	GND	GND	GND
	6	DSR	-----	RTS-	-----
	7	RTS	-----	RTS+	-----
	8	CTS	-----	CTS+	-----
	9	RI	-----	CTS-	-----

2.3.5 PoE (Power over Ethernet) Ports

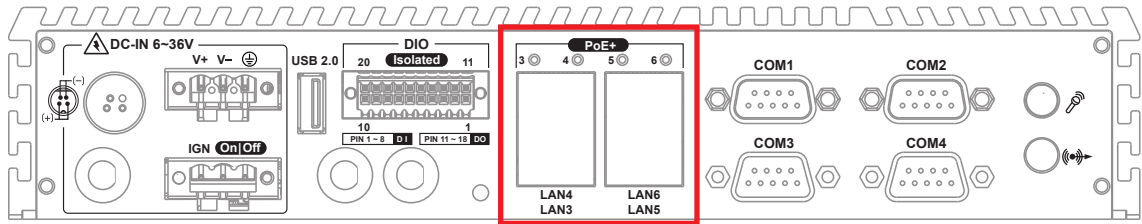

There are 4 RJ45 connectors in the rear side of Echo-40F. It supports IEEE 802.3at (PoE⁺) Power over Ethernet (PoE) connection delivering up to 25.5W/48V per port and 1000BASE-T gigabit data signals over standard Ethernet Cat 5/ Cat 6 cable.

Each PoE connection is powered by Intel[®] I210 Gigabit Ethernet controller and independent PCI express interface to connect with multi-core processor for network and data transmit optimization. Only when PoE port starts to supply power to power devices, the dedicated LED will be lightened.

PS. Suggest to use PoE when power input is over 11V

2.3.6 Audio Connector

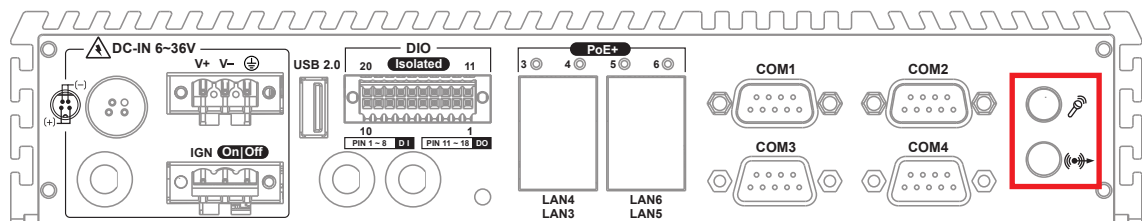

There are 2 audio connectors, Mic-in and Line-out, in the front side of Echo-40F. Onboard Realtek ALC892 audio codec supports 5.1 channel HD audio and fully complies with Intel[®] High Definition Audio (Azalia) specifications.

To utilize the audio function in Windows platform, you need to install corresponding drivers for both Intel[®] Broadwell-U chipset and Realtek ALC892 codec. Please refer to Chapter 4 for more details of driver installation.

2.4 Main Board Expansion Connectors

2.4.1 Front View of Echo-40F Main Board With Connector Location

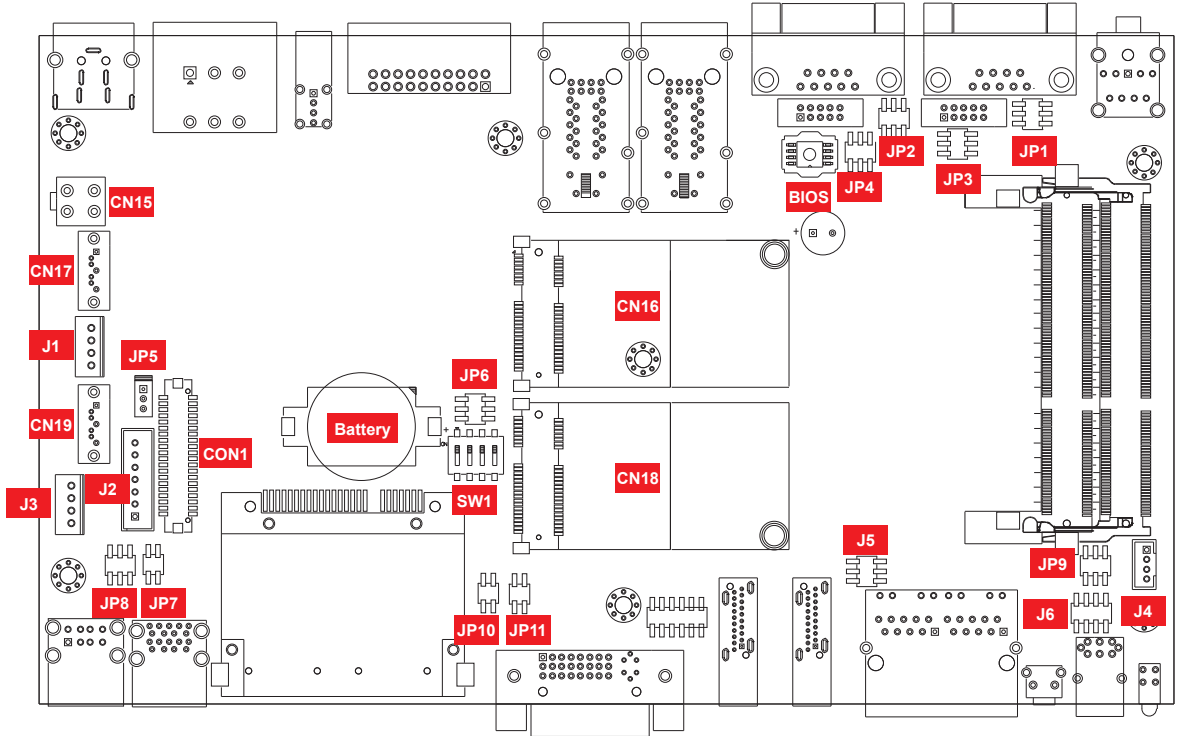

2.4.2 Rear View of Echo-40F Main Board With Connector Location

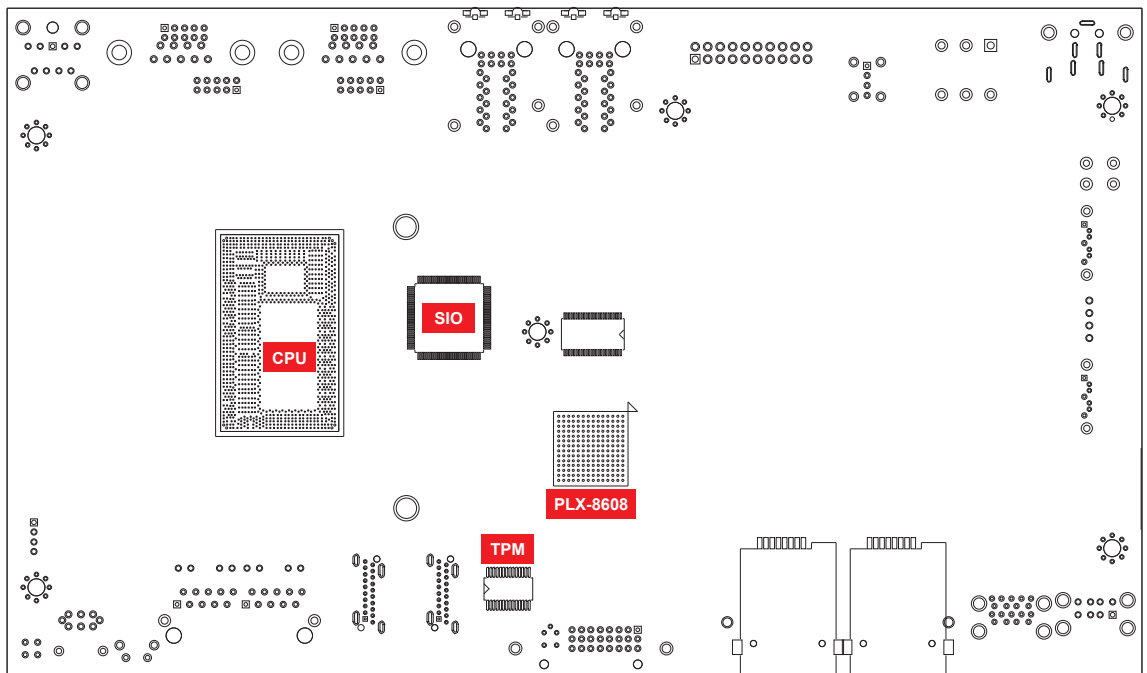

2.4.3 J6 Miscellaneous Pin Header

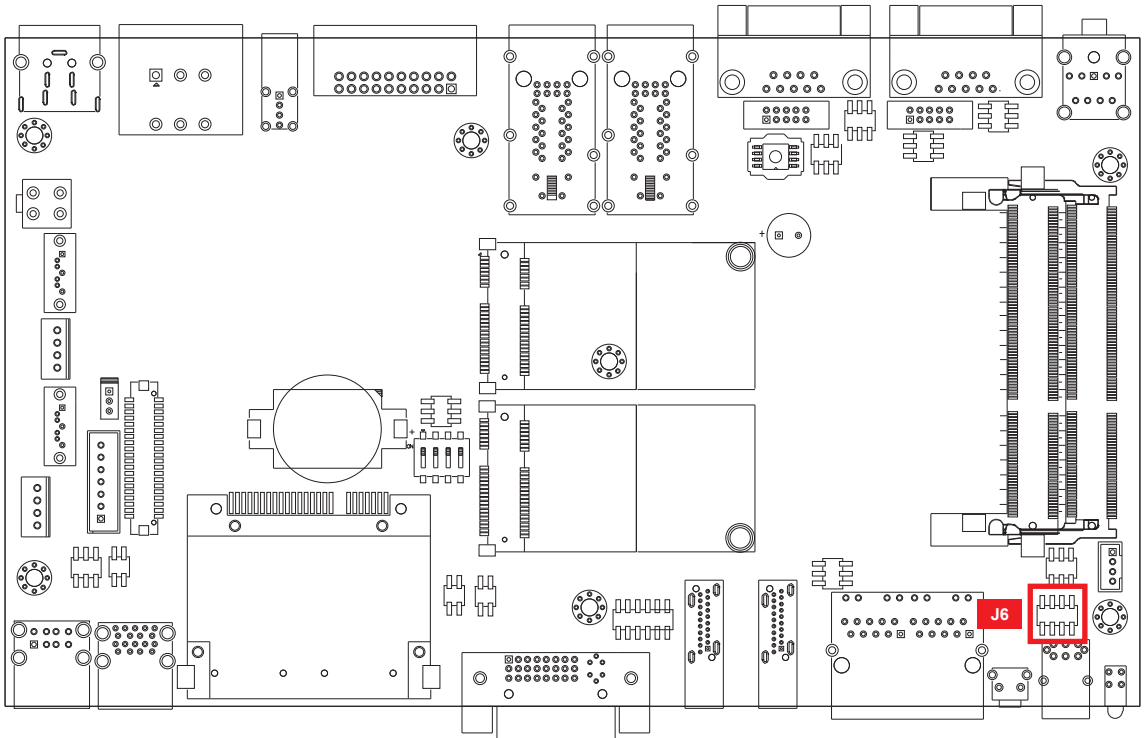

This pin header can be used as a backup for following functions, hard drive LED indicator, reset button, power LED indicator, and power-on/ off button, which already can be accessed by front panel and top panel. The pinouts of Miscellaneous port are listed in following table:

Group	Pin No.	Description
HDD LED	1	HDD_LED_P
	3	HDD_LED_N
RESET BUTTON	5	FP_RST_BTN_N
	7	GND
POWER LED	2	PWR_LED_P
	4	PWR_LED_N
POWER BUTTON	6	FP_PWR_BTN_IN
	8	GND

2.4.4 CON1, J2 LVDS

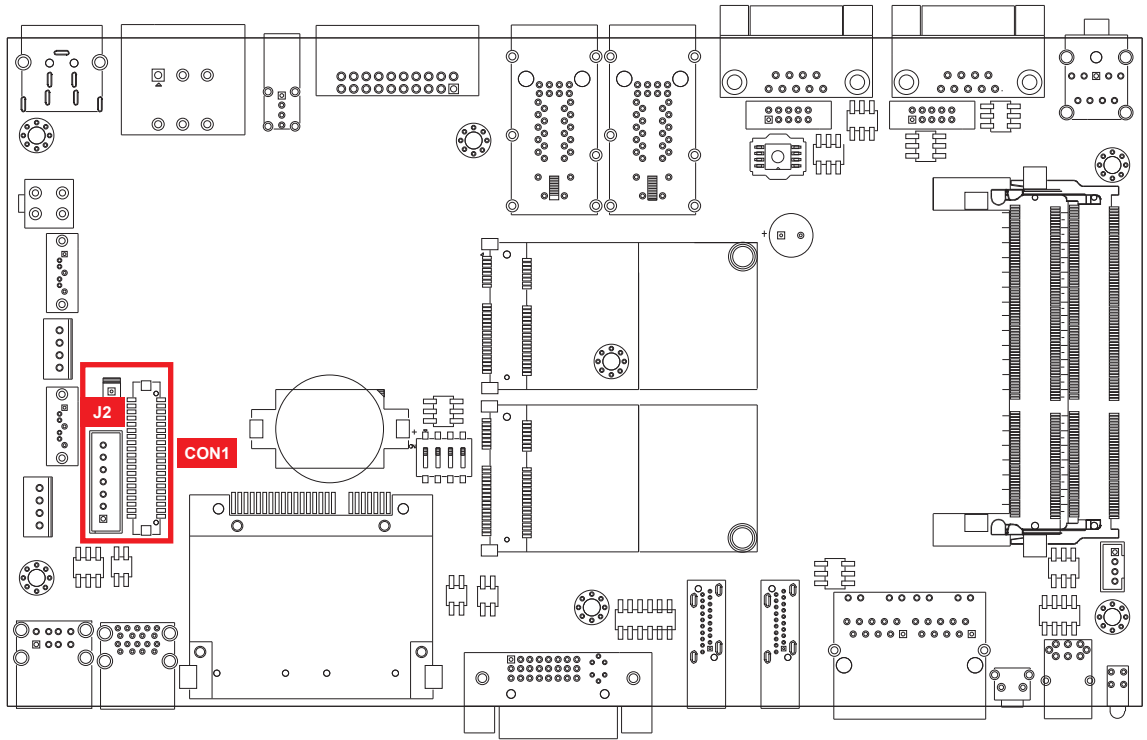

Echo-40F supports dual-channel 24-bit LVDS display, up to 1920 x 1200 pixels resolution. The pin assignments of CON1 are listed in the following table:

Pin No.	Definition	Pin No.	Definition	Pin No.	Definition
1	PANEL_VDD	15	GND	29	GND
2	TXO0-	16	TXOC+	30	TXE2-
3	PANEL_VDD	17	GND	31	GND
4	TXO0+	18	TXO3-	32	TXE2+
5	PANEL_VDD	19	GND	33	GND
6	TXO1-	20	TXO3+	34	TXEC-
7	GND	21	GND	35	GND
8	TXO1+	22	TXE0-	36	TXEC+
9	GND	23	GND	37	GND
10	TXO2-	24	TXE0+	38	TXE3-
11	GND	25	GND	39	LVDS_DET#
12	TXO2+	26	TXE1-	40	TXE3+
13	GND	27	GND		
14	TXOC-	28	TXE1+		

The LCD inverter is connected to J2 via a JST 7-pin, 2.5mm connector providing +5V/ +12V power to LCD display. The pin assignments are listed in the following table:

Pin No.	Definition	Pin No.	Definition
1	+5V	5	GND
2	+12V	6	GND
3	+12V	7	LBKLT_EN
4	LBKLT_CTL		

2.4.5 CN17, CN19 : SATA III Connector

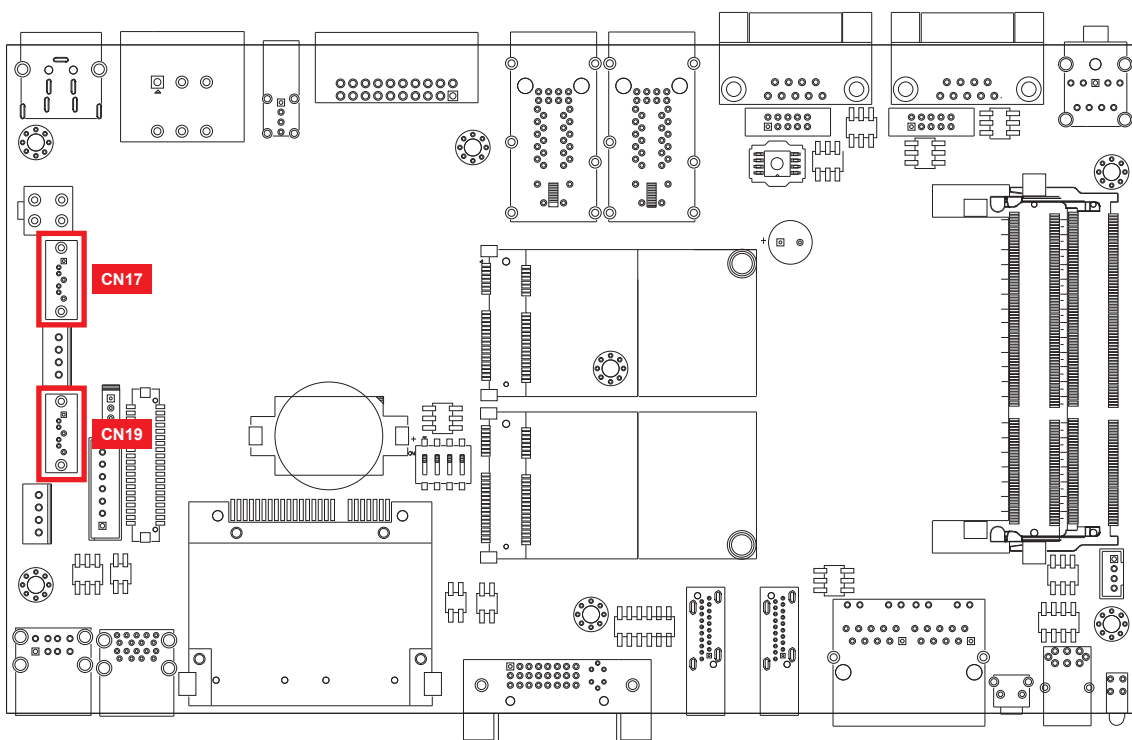

There are 2 onboard high performance Serial ATA III (SATA III) on E&Q Æ €Ø. It supports higher storage capacity with less cabling effort and smaller required space. The pin assignments of CN17 and CN19 are listed in the following table:

Pin No.	Definition	Pin No.	Definition
1	GND	5	RXN
2	TXP	6	RXP
3	TXN	7	GND
4	GND		

2.4.6 J1, J3 : SATA Power Connector

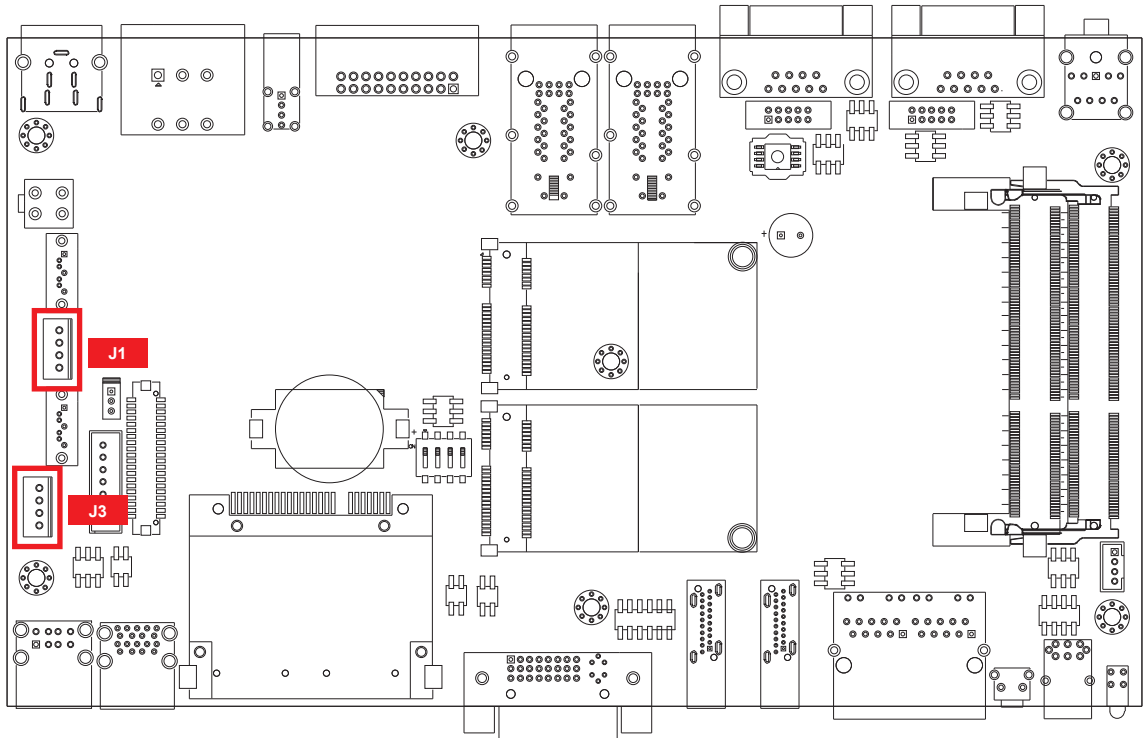

The Echo-40F also equip with 2 SATA power connector. It supports 5V (Up to 2A) and 12V (Up to 1A) current to the hard drive or SSD. The pin assignments of J1 and J3 are listed in the following table:

Pin No.	Definition	Pin No.	Definition
1	+12V	3	GND
2	GND	4	+5V

2.4.7 J4 : Internal USB

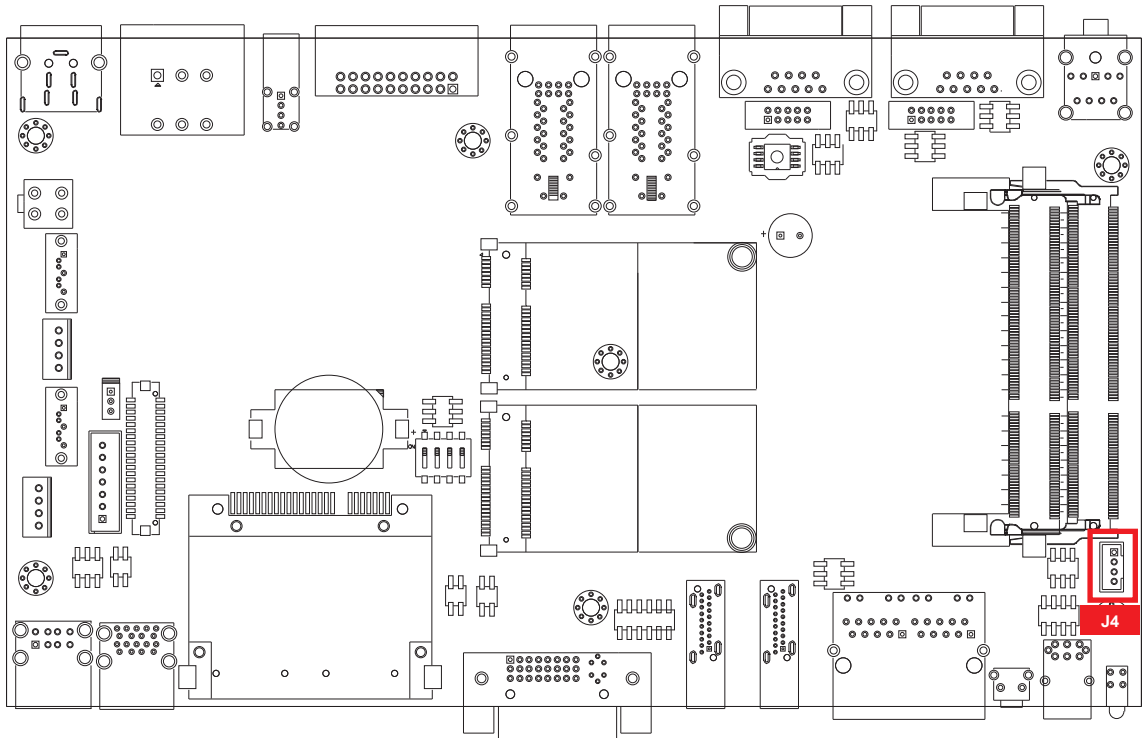

The Echo-40F main board provides one expansion USB port using plug-and-play for Dongle Key or LCD touch Panel. The USB interface supports 480 Mbps transfer rate which complies with high speed USB specification Rev. 2.0.

The USB interface is accessed through one 4-pin JST 2.0mm connector. You will need an adapter cable if you use a standard USB connector. The adapter cable has a 4-pin connector on one end and a USB connector on the other.

The pin assignments of J4 are listed in the following table:

Connector	Pin No.	Description	Pin No.	Description
J4	1	USB_VCC	3	USBD+
	2	USBD-	4	GND

2.4.8 CN18 : Mini PCIe, mSATA

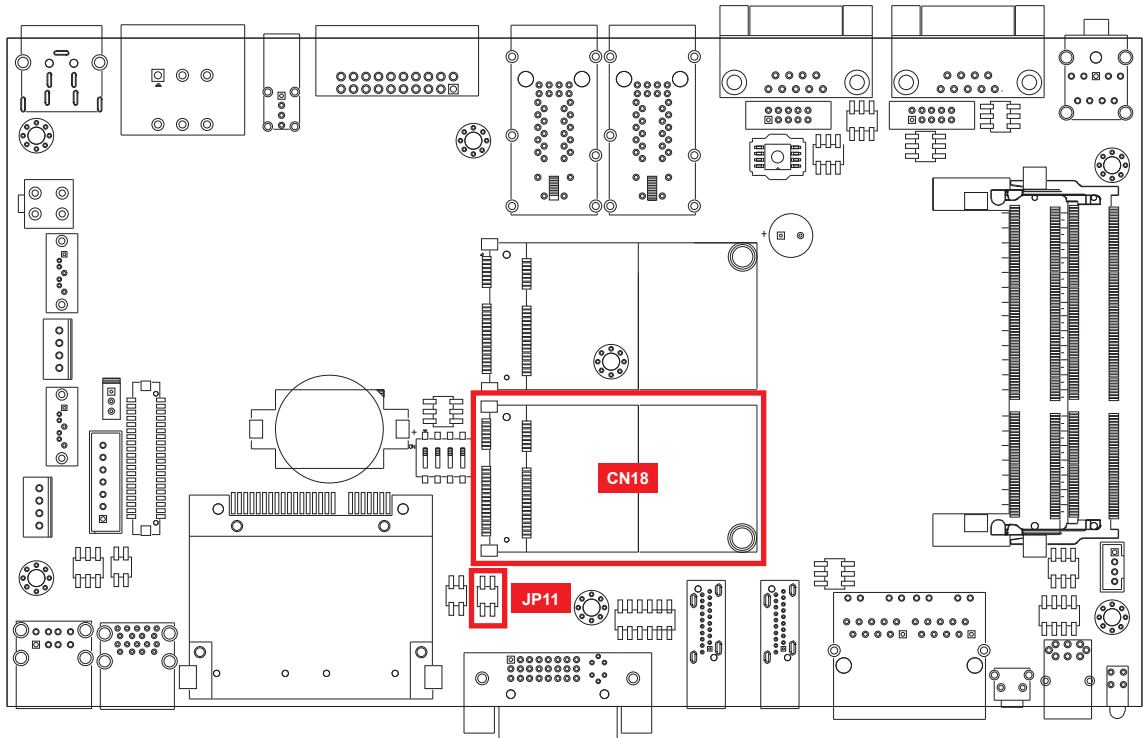

Both mSATA and Mini PCIe share the same form factor and similar electrical pinout assignments on their connectors. There was no clear mechanism to distinguish if a mSATA drive or a Mini PCIe device is plugged into the socket until recently that SATA I/O issued an ECN change (ECN #045) to redefine Pin-43 on mSATA connector as “no connect” instead of “return current path” (or GND).

When an mSATA drive is inserted, its Pin-43 is “no connect”, and the respective pin on the socket is being pulled-up to logic 1. When a Mini PCIe device is inserted, its Pin-43 forces the respective pin on the socket to ground, or logic 0.

IP11 Pin-43 is defined for switching mSATA/ Mini PCIe device, the header definitions are listed in the following table :

Header	Interface
1-2	Auto Detection
2-4	Mini PCIe
1-3	mSATA

The pin assignments of CN18 are listed in the following table:

Pin No.	Signal Name	Pin No.	Signal Name
51	Reserved	52	+3.3Vaux
49	Reserved	50	GND
47	Reserved	48	+1.5V
45	Reserved	46	Reserved
43	Status	44	Reserved
41	+3.3Vaux	42	Reserved
39	+3.3Vaux	40	GND
37	GND	38	USB_D+
35	GND	36	USB_D-
33	PETp0	34	GND
31	PETn0	32	SMB_DATA
29	GND	30	SMB_CLK
27	GND	28	+1.5V
25	PERp0	26	GND
23	PERn0	24	+3.3Vaux
21	GND	22	PERST#
19	Reserved	20	reserved
17	Reserved	18	GND
Mechanical Key			
15	GND	16	UIM_VPP
13	REFCLK+	14	UIM_RESET
11	REFCLK-	12	UIM_CLK
9	GND	10	UIM_DATA
7	CLKREQ#	8	UIM_PWR
5	Reserved	6	1.5V
3	Reserved	4	GND
1	WAKE#	2	3.3Vaux

2.4.9 CN16 : Mini PCIe

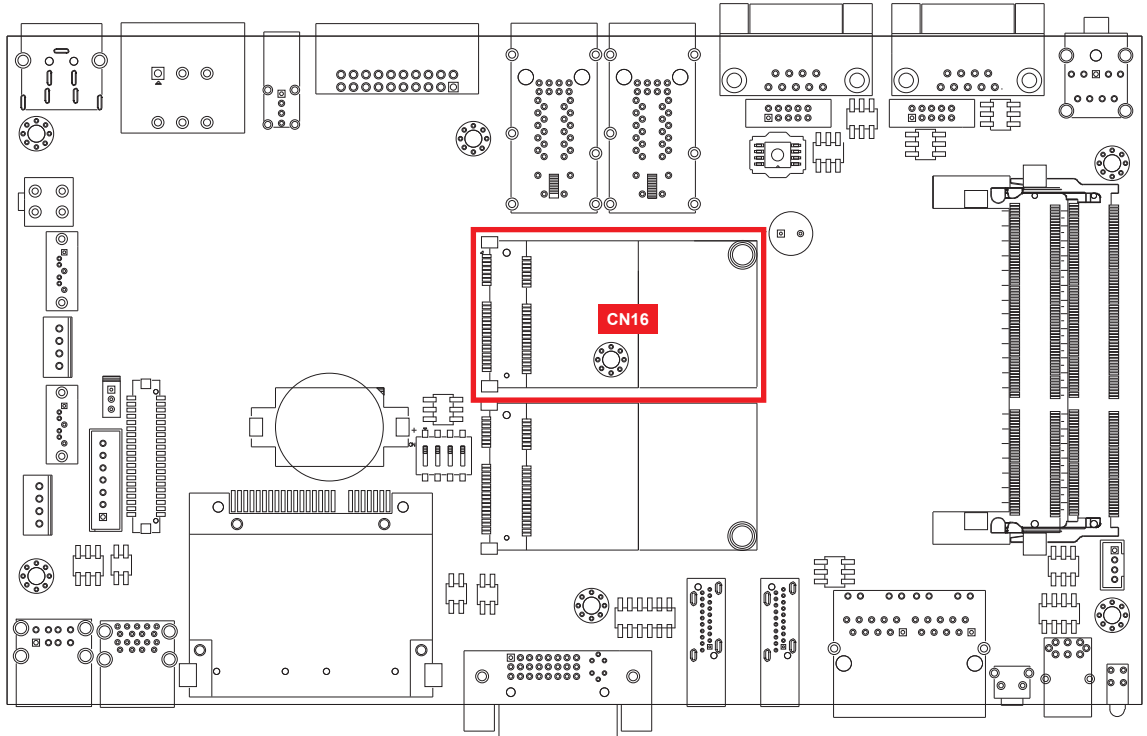

The pin assignments of CN16 are listed in the following table:

Pin No.	Signal Name	Pin No.	Signal Name
51	Reserved	52	+3.3Vaux
49	Reserved	50	GND
47	Reserved	48	+1.5V
45	Reserved	46	Reserved
43	GND	44	Reserved
41	+3.3Vaux	42	Reserved
39	+3.3Vaux	40	GND
37	GND	38	USB_D+
35	GND	36	USB_D-
33	PETp0	34	GND
31	PETn0	32	SMB_DATA
29	GND	30	SMB_CLK
27	GND	28	+1.5V
25	PERp0	26	GND
23	PERn0	24	+3.3Vaux

21	GND	22	PERST#
19	Reserved	20	reserved
17	Reserved	18	GND
Mechanical Key			
15	GND	16	UIM_VPP
13	REFCLK+	14	UIM_RESET
11	REFCLK-	12	UIM_CLK
9	GND	10	UIM_DATA
7	CLKREQ#	8	UIM_PWR
5	Reserved	6	1.5V
3	Reserved	4	GND
1	WAKE#	2	3.3Vaux

2.4.10 Battery

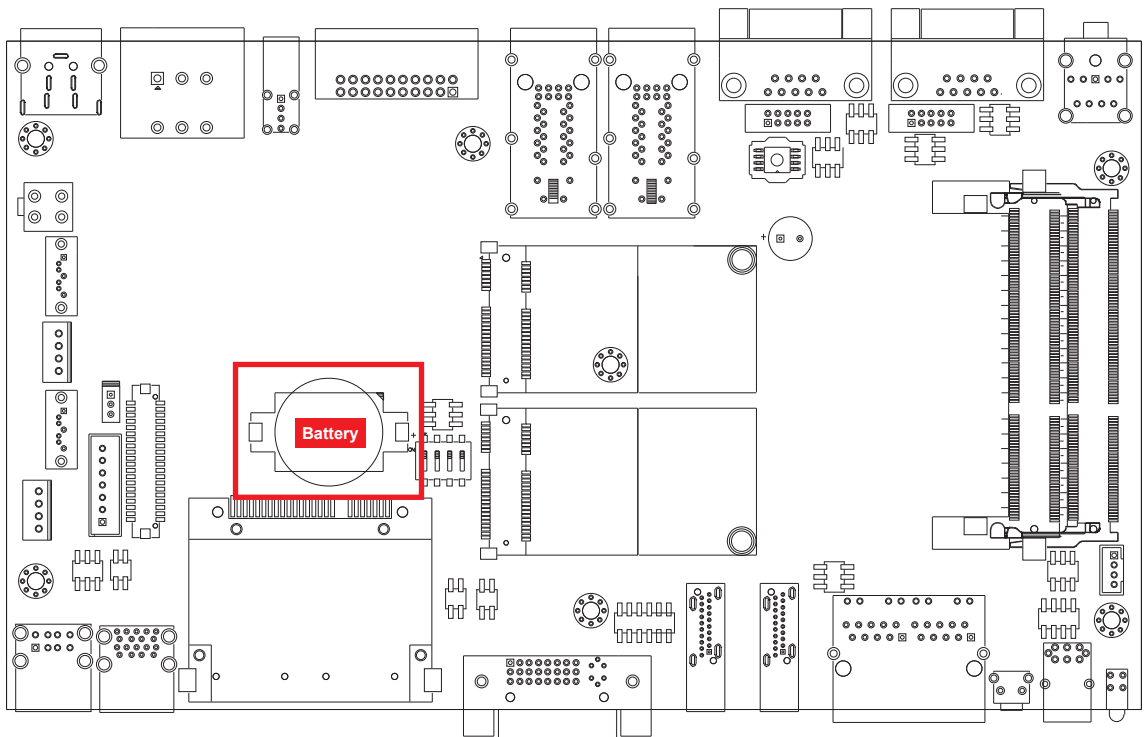

The Echo-40F's real-time clock is powered by a lithium battery. It is Equipped with Panasonic BR2032 190mAh lithium battery. It is recommended that you not replace the lithium battery on your own. If the battery needs to be changed, please contact the Unicomp RMA service team.

2.4.11 J5 : LAN2 I210 SDP

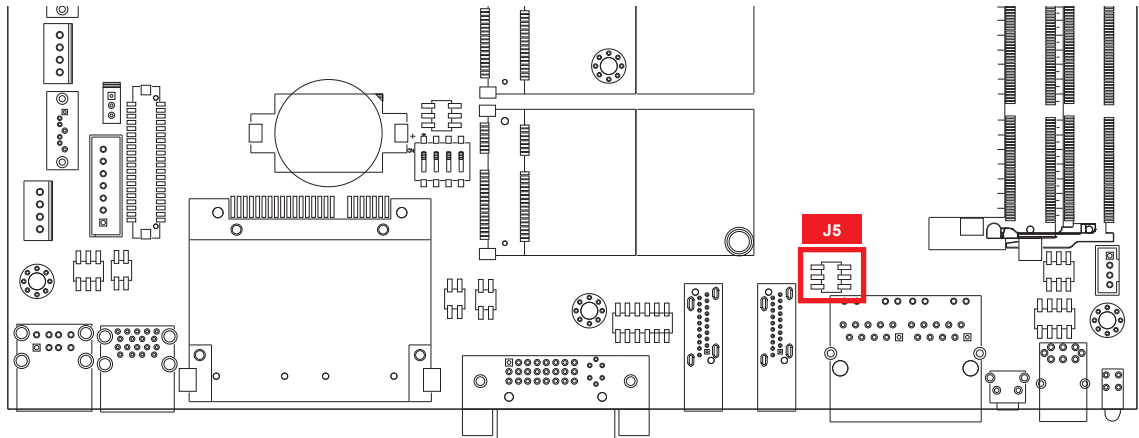

The pin assignments of J5 are listed in the following table:

Pin No.	Function	Pin No.	Function
1	LAN2_SDP0	4	LAN2_SDP3
2	LAN2_SDP1	5	GND
3	LAN2_SDP2	6	GND

2.4.12 CN15 : +12V_SB Output

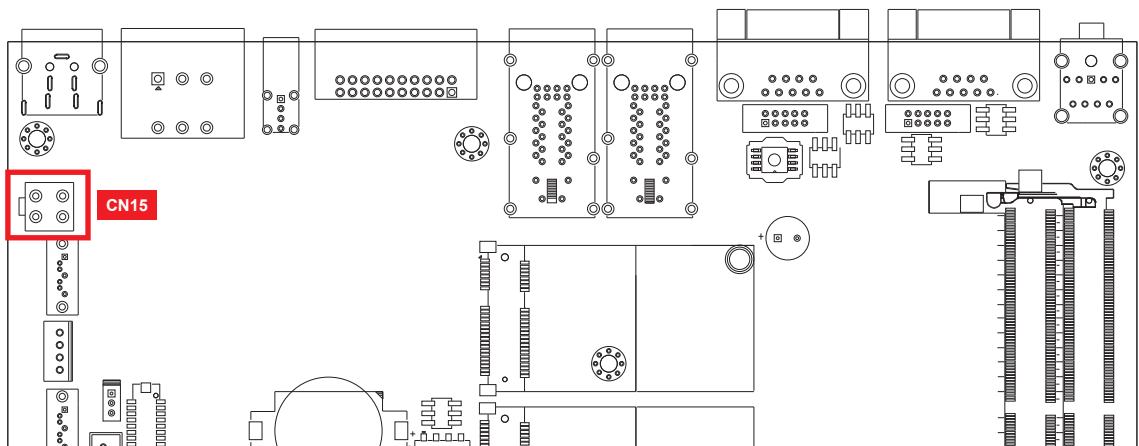

The pin assignments of CN15 are listed in the following table:

Pin No.	Function	Pin No.	Function
1	GND	3	+12V_SB
2	GND	4	+12V_SB

2.5 Main Board Jumper Settings

2.5.1 Front View of Echo-40F Main Board with Jumper Location

The figure below is the top view of the Echo-40F main board which is the main board used in the Echo Series system. It shows the location of the jumpers.

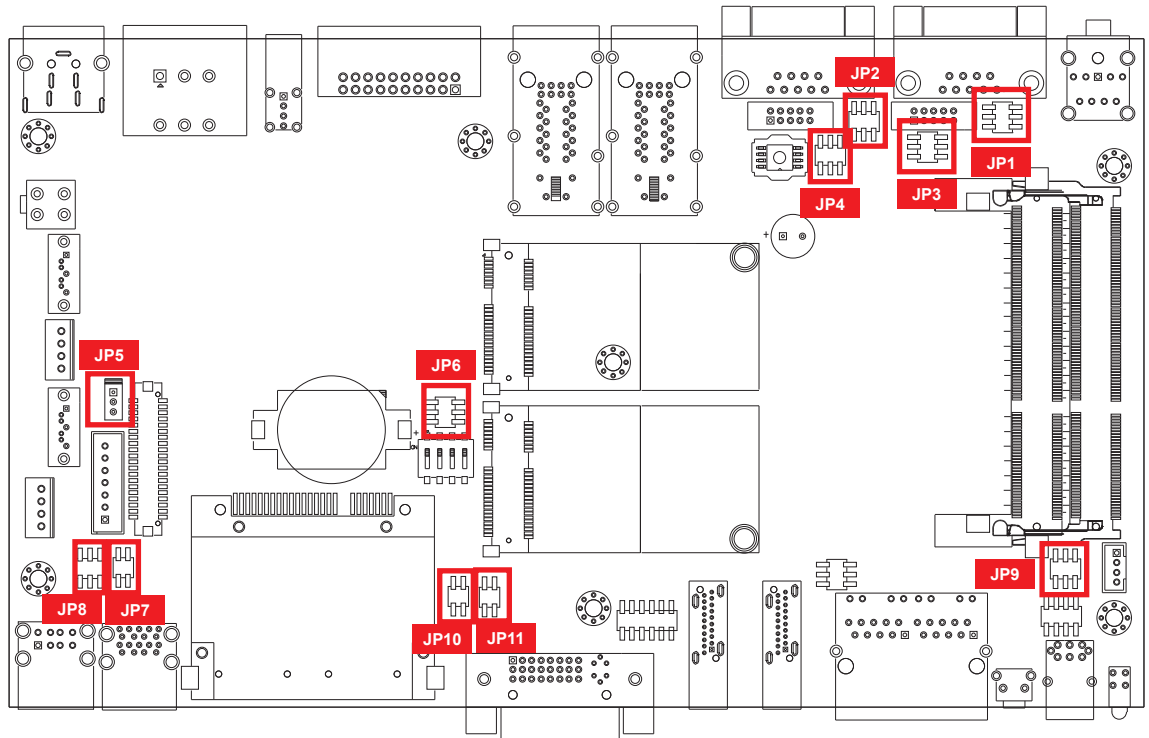

You may configure your card to match the needs of your application by setting jumpers. A jumper is a metal bridge used to close an electric circuit. It consists of two metal pins and a small metal clip (often protected by a plastic cover) that slides over the pins to connect them. To “close” a jumper, you connect the pins with the clip. To “open” a jumper, you remove the clip. Sometimes a jumper will have three pins, labeled 1, 2 and 3. In this case you would connect either pins 1 and 2, or 2 and 3.

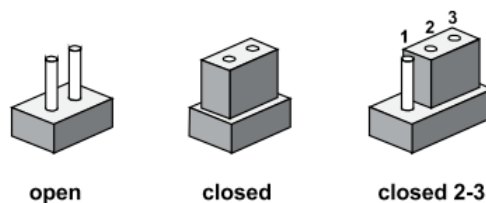

2.5.2 JP1, JP2, JP3, JP4

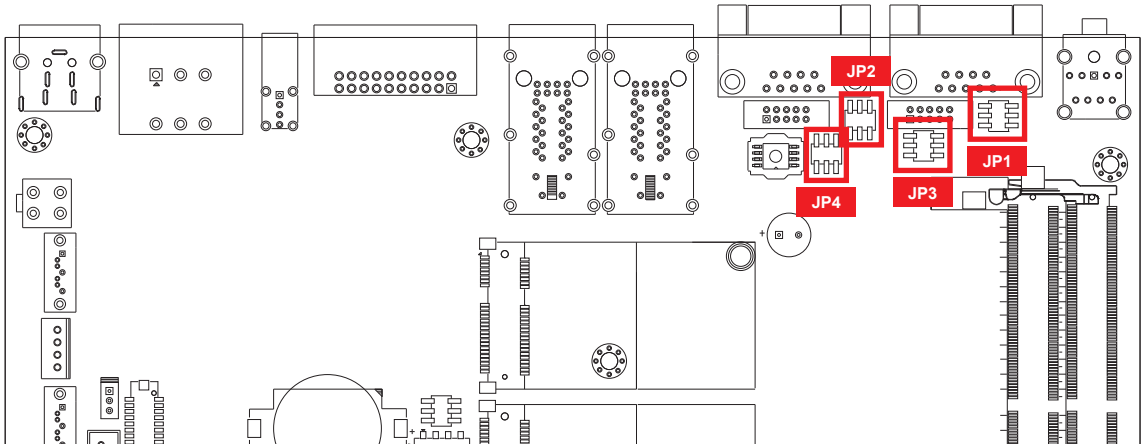

COM 1 to COM 4 Pin 9 Function:

Pin No.	RI/ +5V/ +12V
1-2	+12V
3-4	+5V
5-6	RI

2.5.3 JP5 : LVDS Backlight, Power Selection

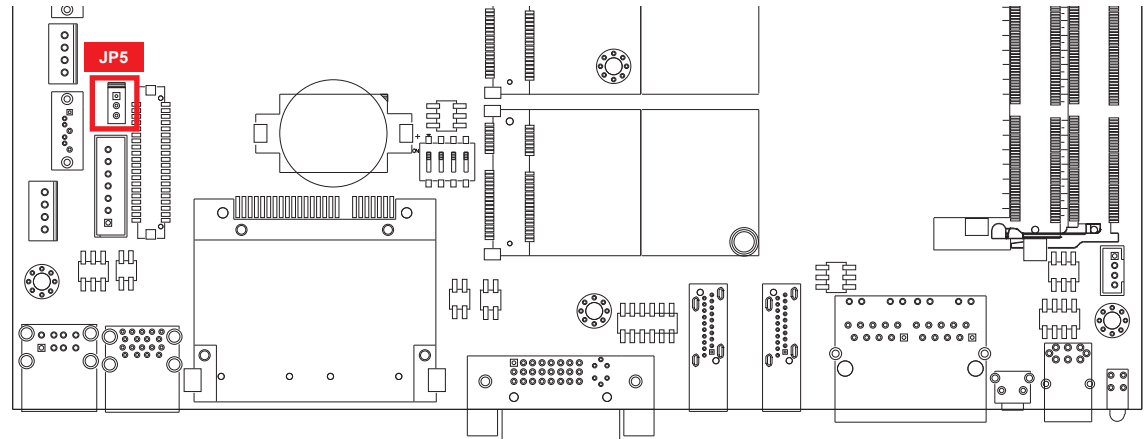

JP5 provides LVDS voltage selection function, closing Pin 1, 2 is for 3.3V LVDS power input; closing Pin 2, 3 is for 5V LVDS power input.

Pin No.	Function	Pin No.	Function
1-2	+3.3V (Default)	2-3	+5V

2.5.4 JP6 CMOS/ME

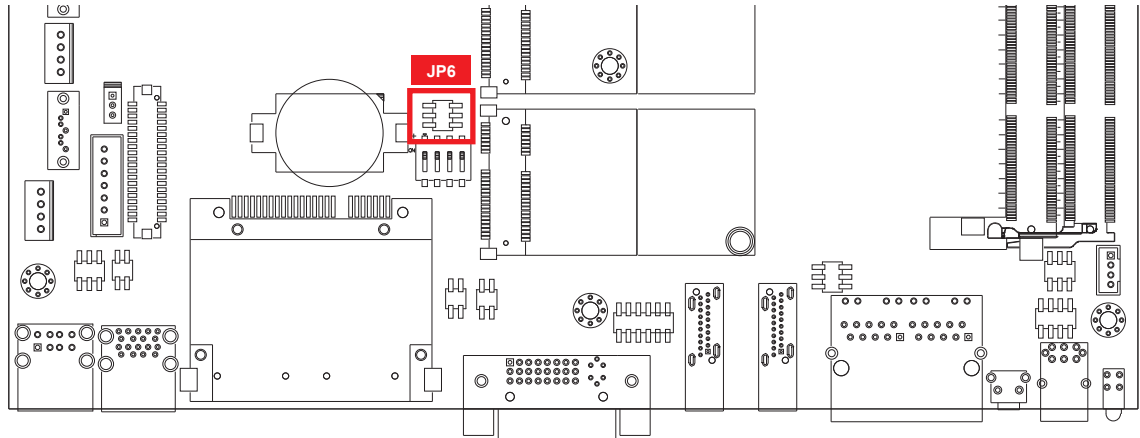

CMOS	Header	ME	Header
1-2	Normal	2-4	Normal
2-3	Clear CMOS	4-6	Clear ME

2.5.5 JP7 External USB3.0/2.0 Power Select

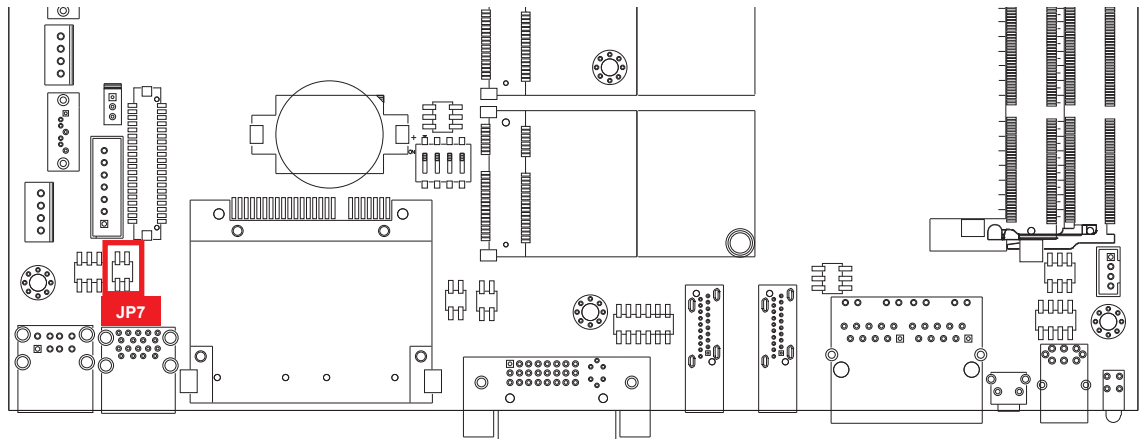

Header	Power	Header	Power
1-2	+5V Standby Power	3-4	+5V System Power

2.5.6 JP9 Internal USB Power Select

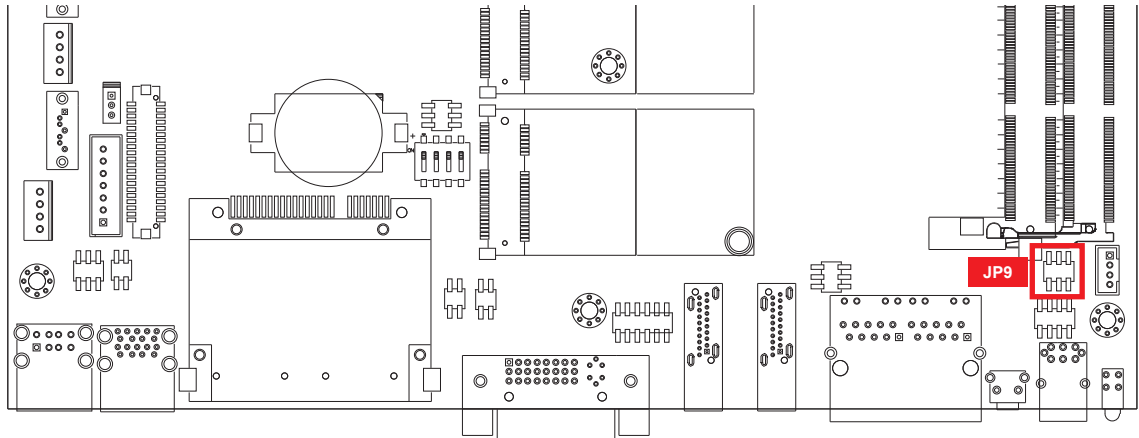

Internal USB PWR Select:

JP9	+V5A/ +V5/ +V3.3
1-2	+5V Standby
3-4	+5V
5-6	+3.3V

2.5.7 JP10 : MCU Spy-bi Wire Interface for Download FW

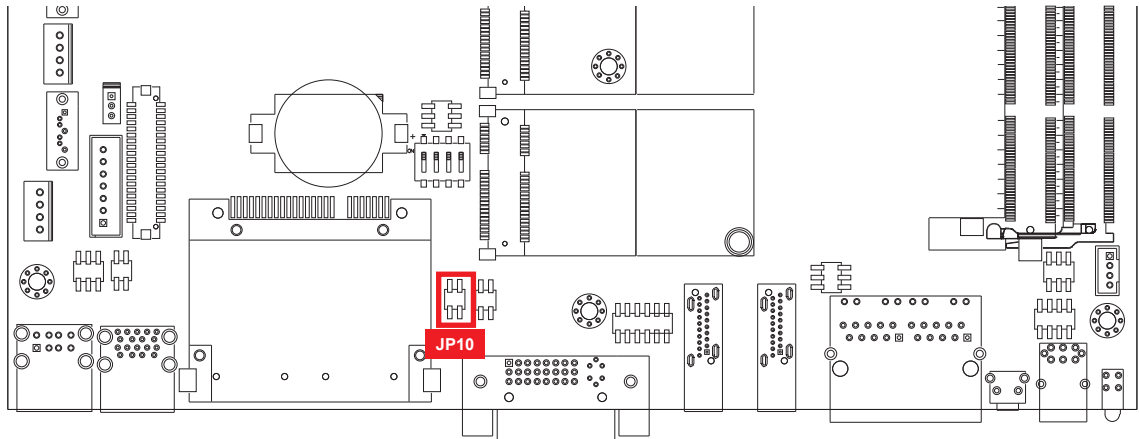

The pin assignments of JP10 are listed in the following table:

Pin No.	Function	Pin No.	Function
1	GND	3	3.3V_MCU
2	MCU_RST#	4	MCU_PRG

2.5.8 JP8 Backlight Control Level Select

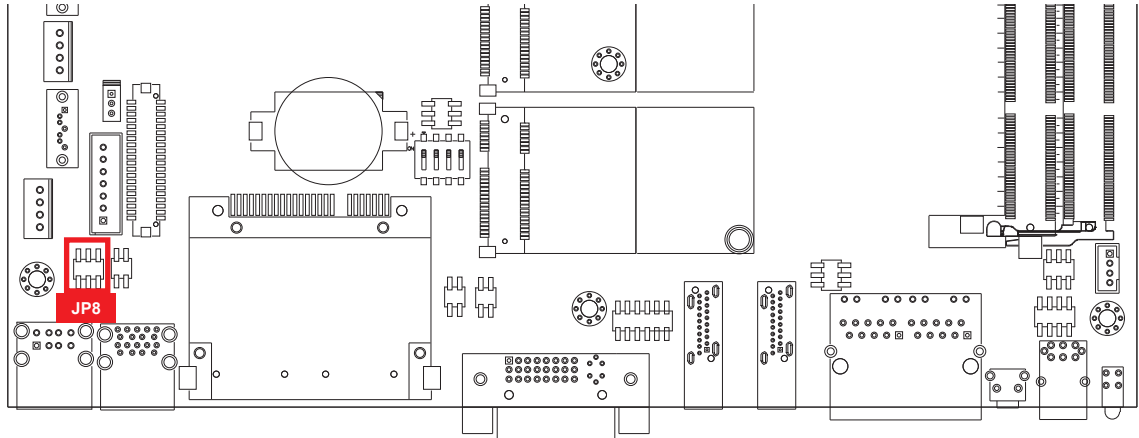

Dimming	Header
1-3	3.3V
3-5	5V

On/ Off	Header
2-4	3.3V
4-6	5V





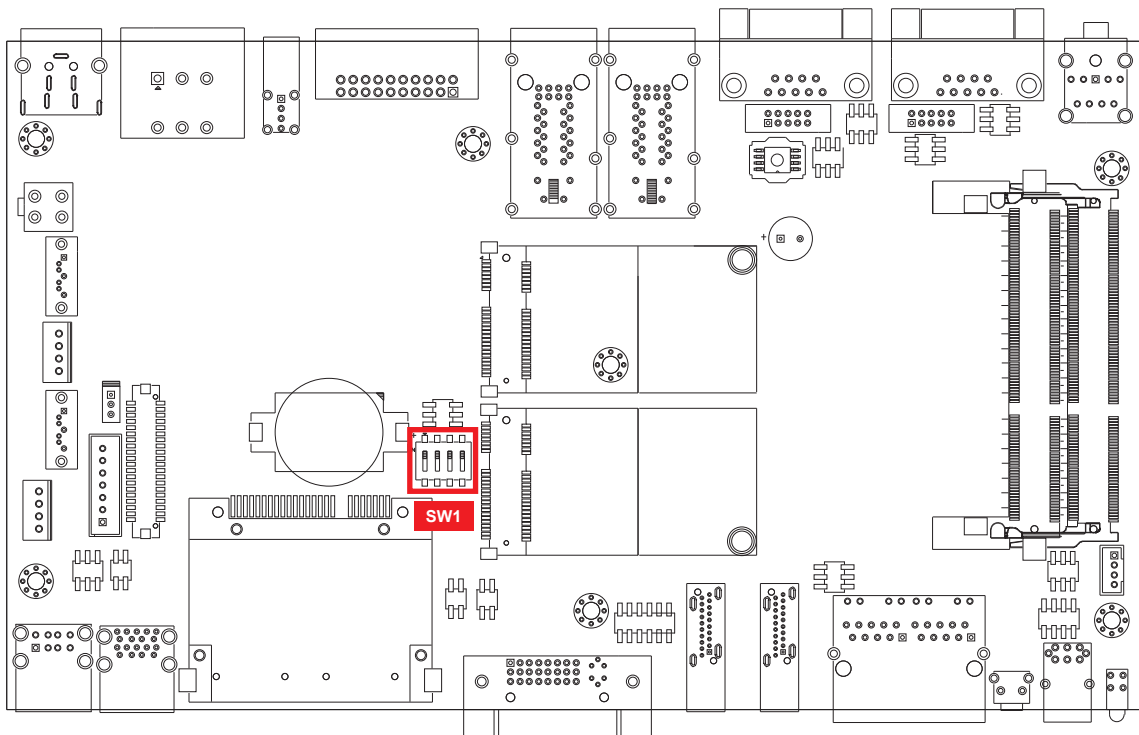







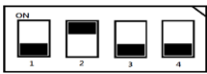

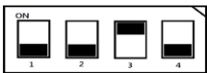
2.6 Ignition Control

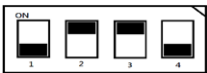
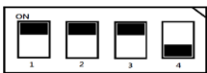
E&Q EØ series provides ignition power control feature for in-vehicle applications. The built-in MCU monitors the ignition signal and turns on/ off the system according to pre-defined on/ off delay period.



2.6.1 Adjust Ignition Control Modes

E&Q Æ €Ø series provides 16-mode adjustable power on/ off delay period via DIP-Switch. The default DIP-Switch is set to 0 in ATX/ AT power mode. The modes are listed in below table:

DIP-Switch Position	Power on delay	Power off delay	Switch Position
0	ATX/AT mode		
1	No delay	No delay	
2	No delay	5 seconds	
3	No delay	10 seconds	
4	No delay	20 seconds	
5	5 seconds	30 seconds	
6	5 seconds	60 seconds	
7	5 seconds	90 seconds	
8	5 seconds	30 minutes	
9	5 seconds	1 hour	
A	10 seconds	2 hours	
B	10 seconds	4 hours	
C	10 seconds	6 hours	
D	10 seconds	8 hours	
E	10 seconds	12 hours	
F	10 seconds	24 hours	

2.6.2 Ignition Control Wiring

To activate ignition control, you need to provide IGN signal via the 3-pin pluggable terminal block locates in the back panel. Please find below the general wiring configuration.

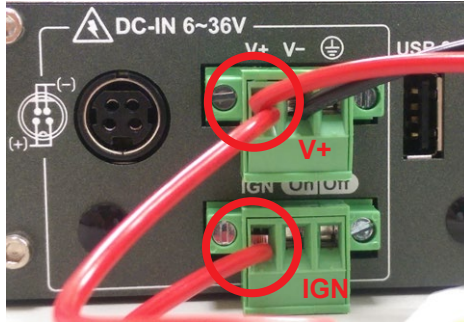

V+ : Positive polarity of DC power input (Car battery+ for 12/24V)

V- : Ground of DC power input (Car battery -/GND line to GND)

IGN : Ignition signal input (ACC power of vehicle)

For testing purpose, you can refer to the picture blow to simulate ignition signal input controlled by a latching switch.

Note:

1. DC power source and IGN share the same ground.
2. E&@ Ę €Ø supports 6V to 36V wide range DC power input in ATX/AT mode. In Ignition mode, the input voltage is fixed to 12/24V for car battery scenario.
3. For proper ignition control, the power button setting should be “Power Down” mode.

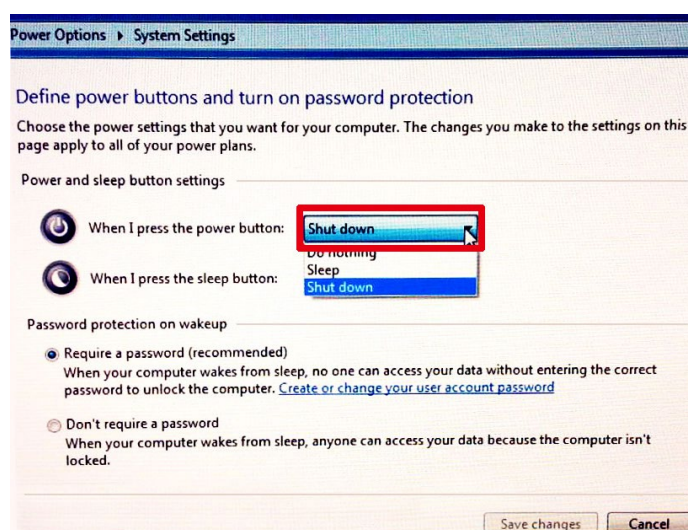

In Windows for example, you need to set “When I press the power button” to Shut down.

3

SYSTEM SETUP

“Please make sure to assemble the system in an anti-static environment.”

3.1 How to Open Your EULaZ&" 8

3.1.1 Echo-40F-PoE/ Echo-40F-2G

Step 1 Remove 5pcs KHS#6-32 screws (circled in red) and 2pcs#4-40 screws (circled in yellow) on the front panel.



Step 2 Take off the front panel.



Step 3 Remove 4pcs F#6-32x6 screws (circled in red) in the bottom side.

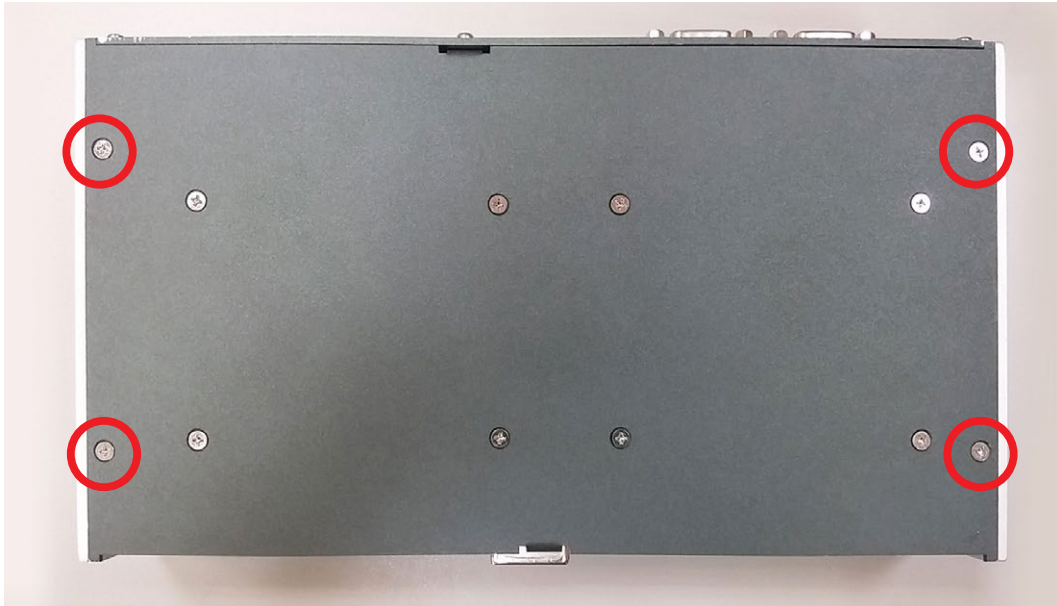

Step 4 Remove 1pcs KHS#6-32 screw (circled in red) on the rear panel.

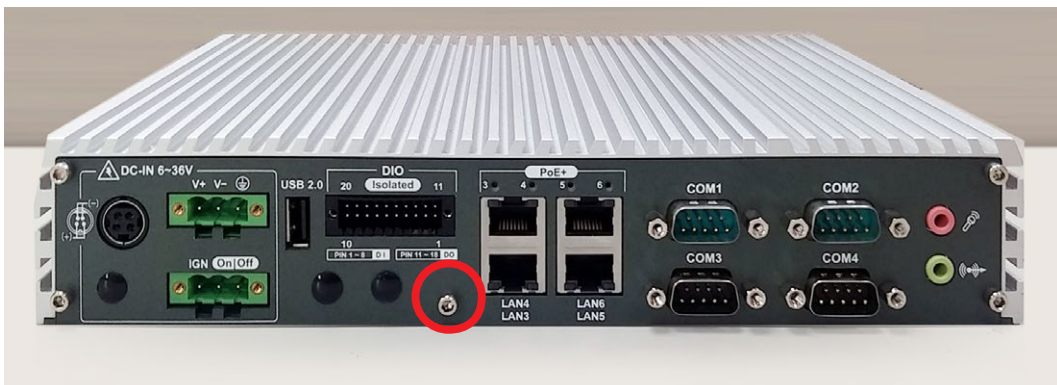

Step 5 Turn over E&Q Ę Ę to keep the bottom side up. Then do open the bottom cover carefully.

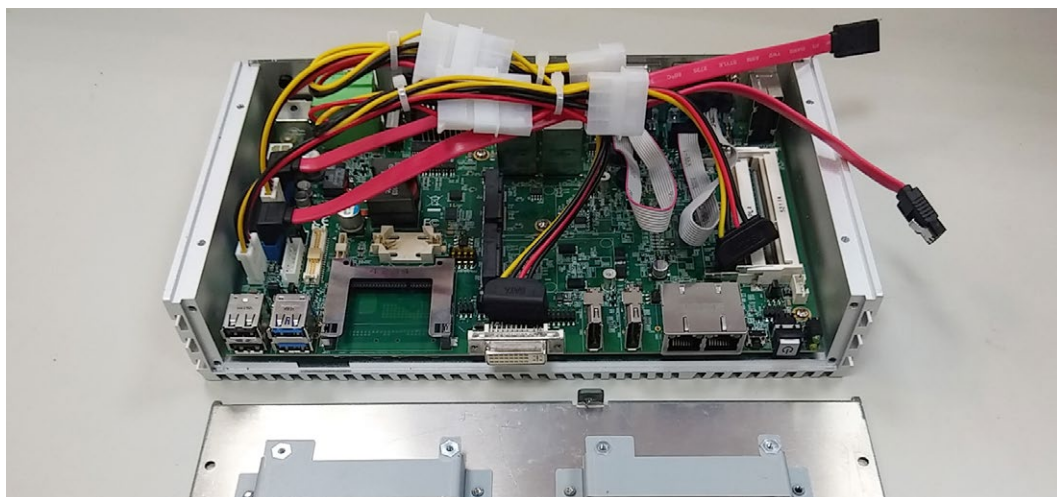

3.1.2 Echo-40F-PoER/ Echo-40F-2R

Step 1 Counterclockwise loosen the locks on each SSD/ HDD Tray.



Step 2 Remove the SSD/ HDD Tray from E&@ Ĩ €Ø-PoER/ E&@ Ĩ €Ø-2R.

Step 3 Remove 5pcs KHS#6-32 screws (circled in red) and 2pcs#4-40 screws (circled in yellow) on the front panel. (E&@ Ĩ €Ø-PoER/ E&@ Ĩ €Ø-2R)



Step 4 Take off the front panel.



Step 5 Remove 4pcs F#6-32x6 screws (circled in red) in the bottom side.

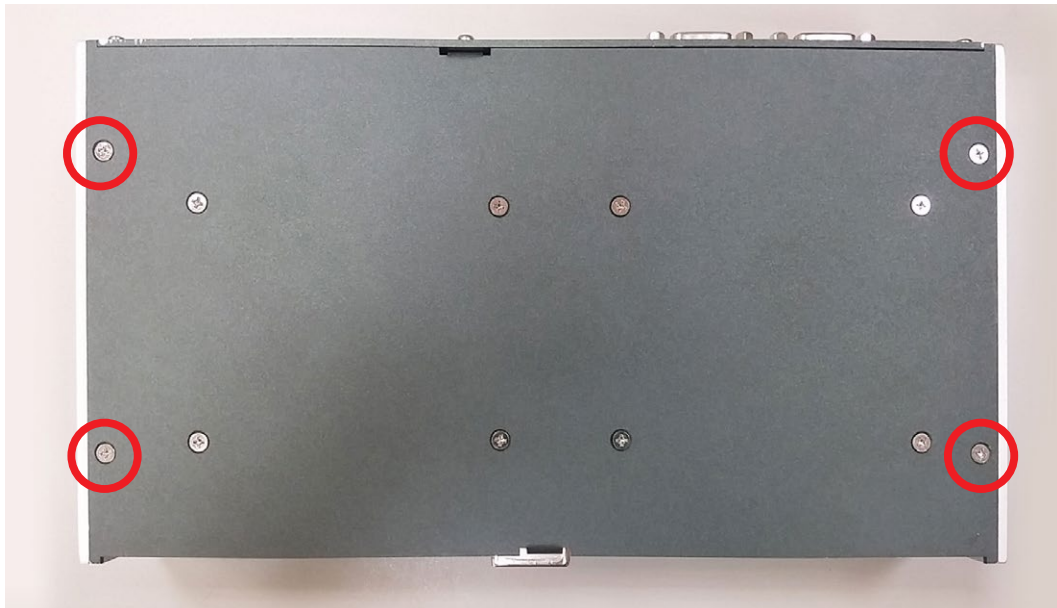

Step 6 Remove 1pcs KHS#6-32 screw (circled in red) on the rear panel.



Step 7 Turn over E&Q Ę Ę to keep the bottom side up. Then do open the bottom cover carefully.

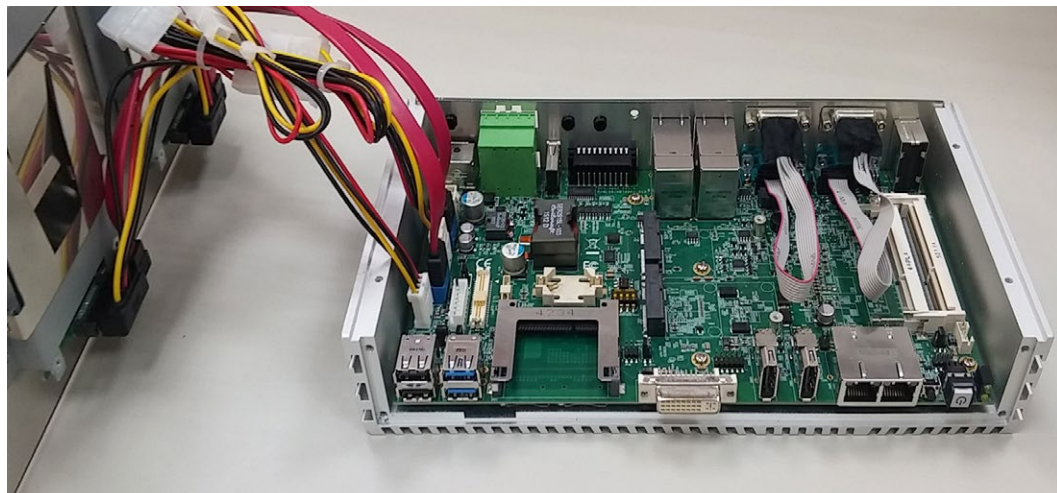

3.2 Installing DDR3L SO-DIMM Modules

Step 1 Install DDR3L RAM module into SO-DIMM slot.
(E&Q ð €-PoER/ E&Q ð €-PoE/ E&Q ð €-2G/ E&Q ð €-2R)



Step 2 Make sure the RAM module is locked by the memory slot.
(E&Q ð €-PoER/ E&Q ð €-PoE/ E&Q ð €-2G/ E&Q ð €-2R)

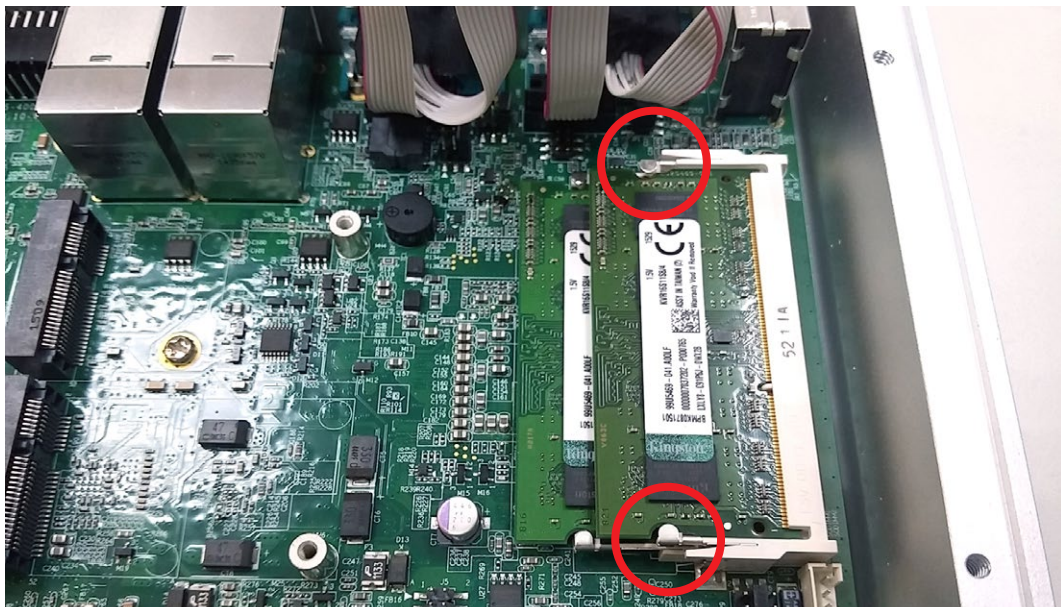

3.3 Installing Mini PCIe Cards

Step 1 Install Mini PCIe card into the Mini PCIe socket.
(E&Q # 0-PoER/ E&Q # 0-PoE/ E&Q # 0-2G/ E&Q # 0-2R)



Step 2 Fasten 2pcs M2.5 screws.
(E&Q # 0-PoER/ E&Q # 0-PoE/ E&Q # 0-2G/ E&Q # 0-2R)



3.4 Installing Antenna Cable

Step 1 Check Antenna cable and washers.

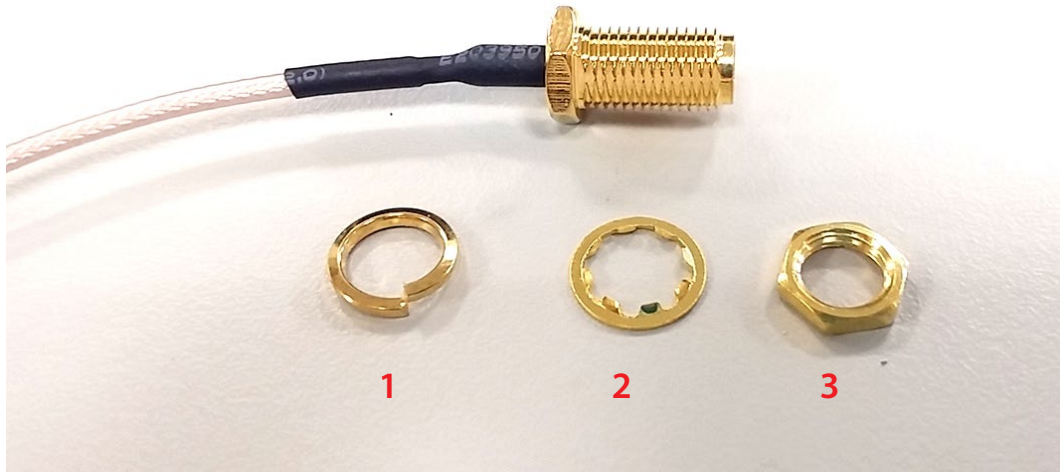

Step 2 Remove 3pcs rubber cork on rear panel.
(Pick up the location you want)



Step 3 Put Antenna cable connector into the hole on rear panel.



Step 4 Fasten the washer 1, washer 2 and washer 3 on Antenna cable connector.



Step 5 Antenna cable is installed ready.



3.5 Installing CFast Card and SIM Card

Step 1 Remove 2pcs M3x4 Flat head screws on CFast & SIM Card cover on front panel.

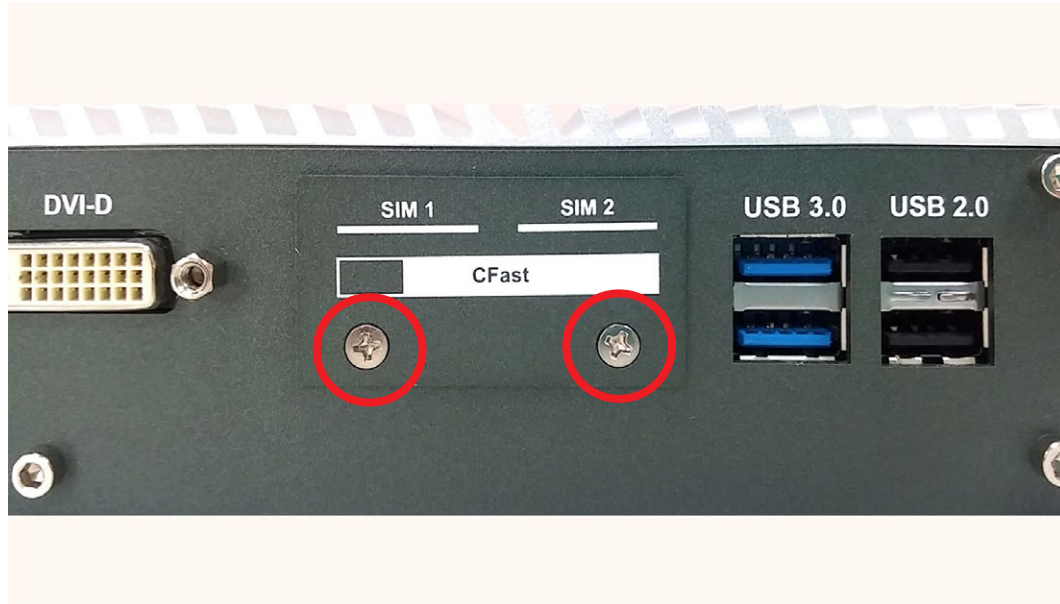

Step 2 Remove CFast Card and SIM Card cover from front panel.



Step 3 Insert CFast card and push to lock.



Step 4 Before Inserting SIM card, make sure the system power is not plugged.

Step 5 Insert SIM card and push to lock.



Step 6 SIM card and CFast card are installed ready.

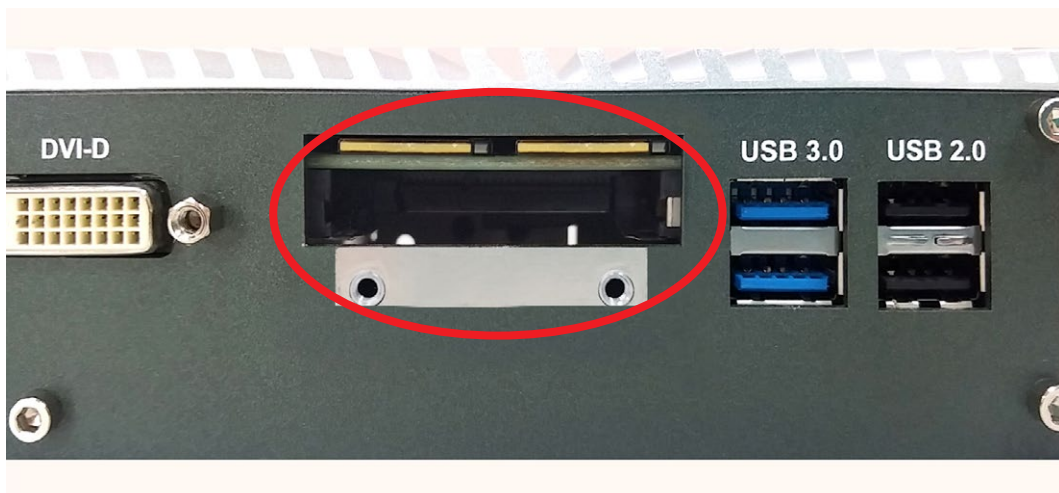

3.6 Installing SSD/HDD

3.6.1 Echo-40F-PoE/ Echo-40F-2G

Step 1 Take the bottom cover from E&Q 40 PoE/ E&Q 40 2G.
(Please refer to [3.1.1](#))

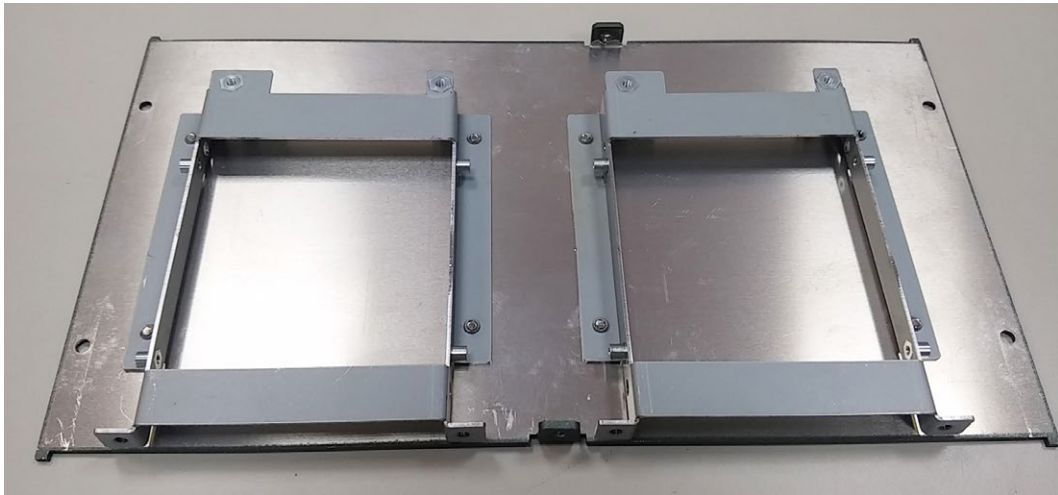

Step 2 Loosen 8pcs M4x4 screws (circled in red) on the bottom cover.

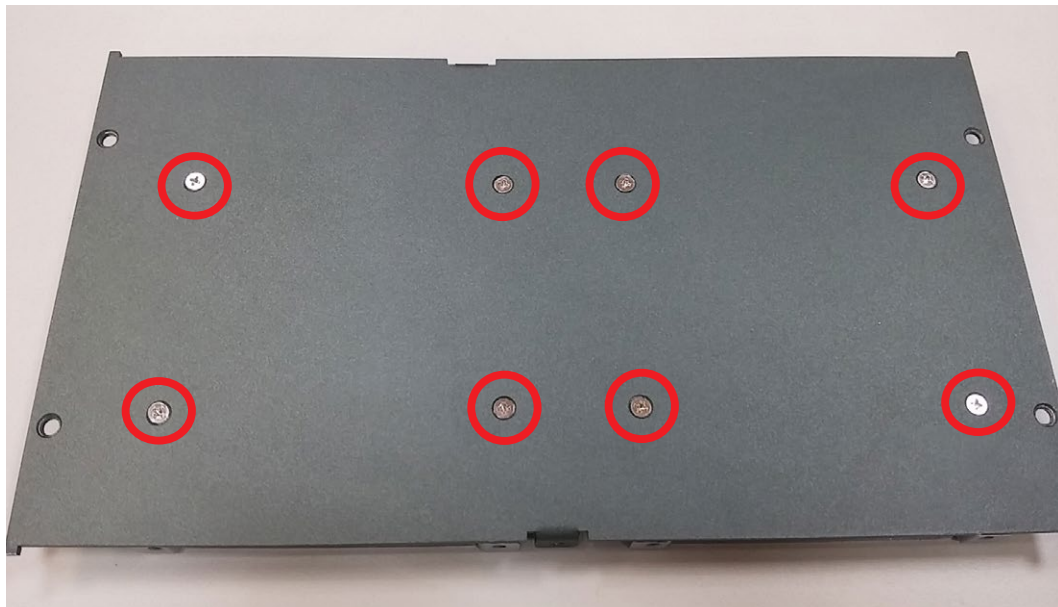

Step 3 Remove the SSD/HDD bracket from E&Q 40 bottom cover.

Step 4 Put 2.5" SSD/HDD into the bracket.



Step 5 Fasten 4 pcs M3 screws to fix the SSD/HDD on the bracket.



Step 6 Fix the SSD/HDD bracket with M3x4 screws.

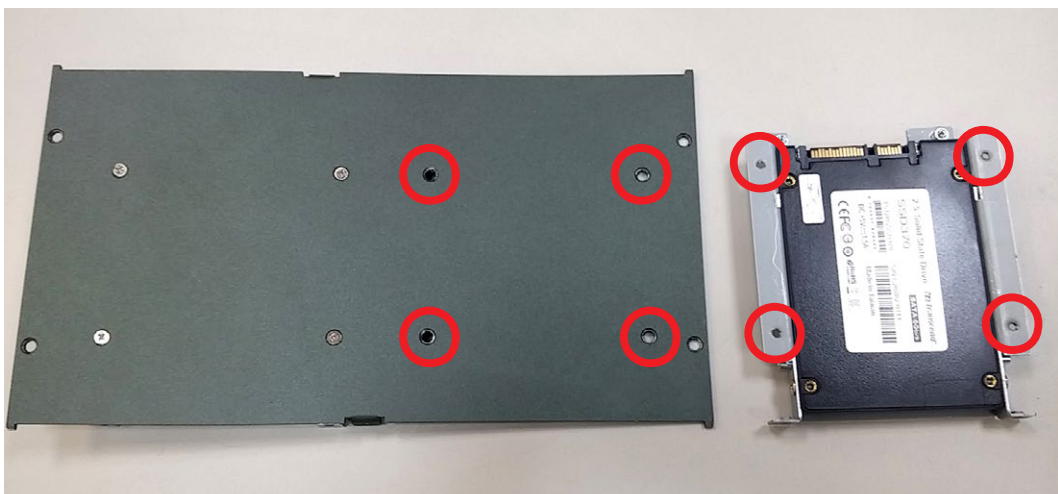

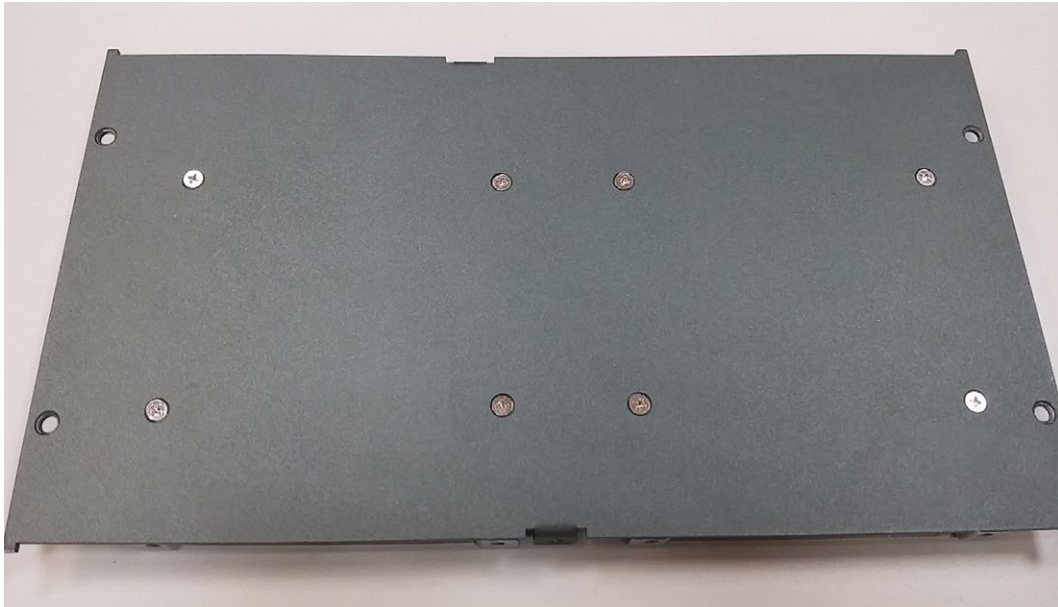

Step 7 Cable to the SSD/HDD.

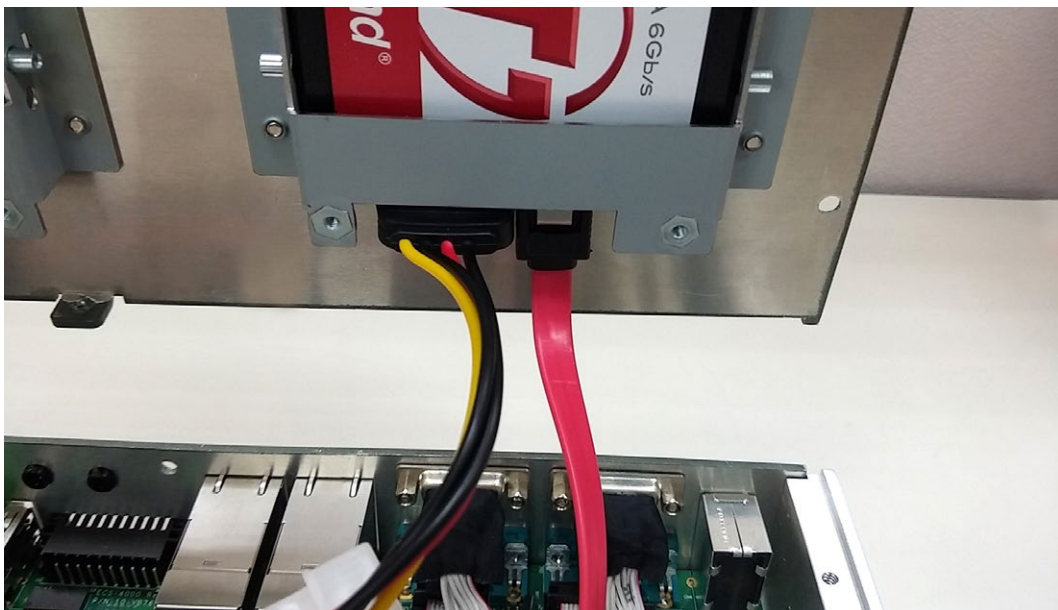

3.6.2 Echo-40F-PoER/ Echo-40F-2R

Step 1 Counterclockwise loosen the locks on each SSD/HDD Tray. Then remove the SSD/HDD Tray from Echo-40F-PoER/ Echo-40F-2R.



Step 2 Fix the SSD/HDD on the SSD/HDD Tray with 2 pcs M3x4 Flat head screws.



Step 3 Put the SSD/HDD Tray back.



Step 4 Clockwise fasten the locks on each SSD/HDD Tray.

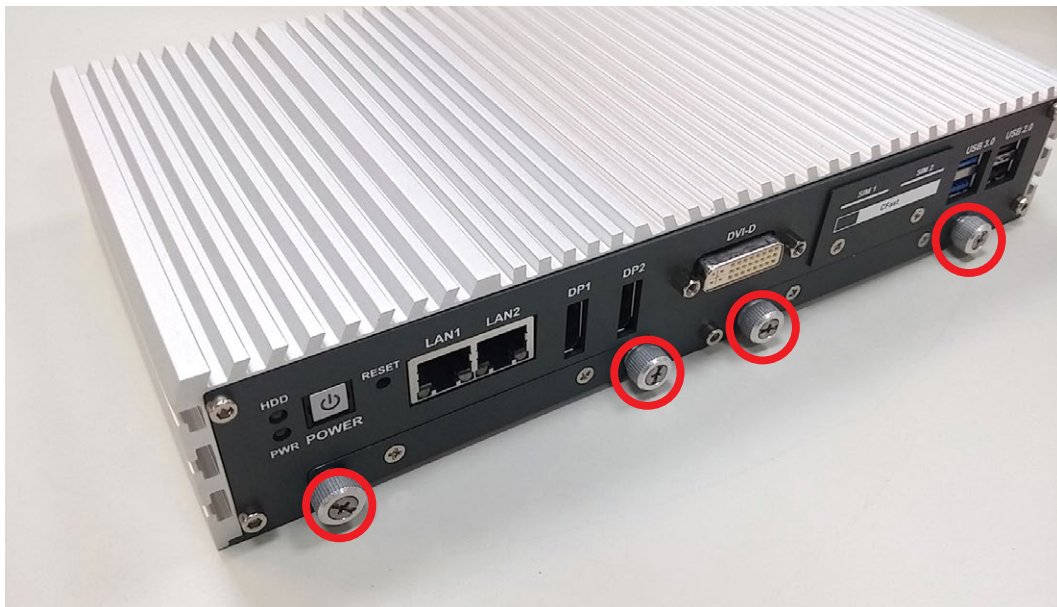

3.7 Mounting 7U Rack 8

Step 1 Ensure the screw holes on the right and left side of upper case match the ones on E&@ 8 wallmount bracket.



Step 2 Fasten 4pcs KHS#6-32 screws.



4

BIOS AND DRIVER SETTING

4.1 BIOS Settings

The board uses UEFI BIOS that is use Serial Peripheral Interface (SPI) Flash. The SPI Flash contains the BIOS Setup program, POST, the PCI auto-configuration utility, LAN, EEPROM information, and Serial port support. The BIOS setup program is accessed by pressing the key after the Power-On Self-Test (POST) memory test begins and before the operating system boot begins. The menu bar is shown below.

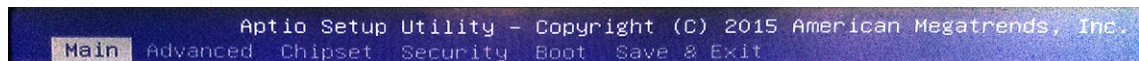

Figure 4-1-1: BIOS Menu Bar

4.2 Main Menu

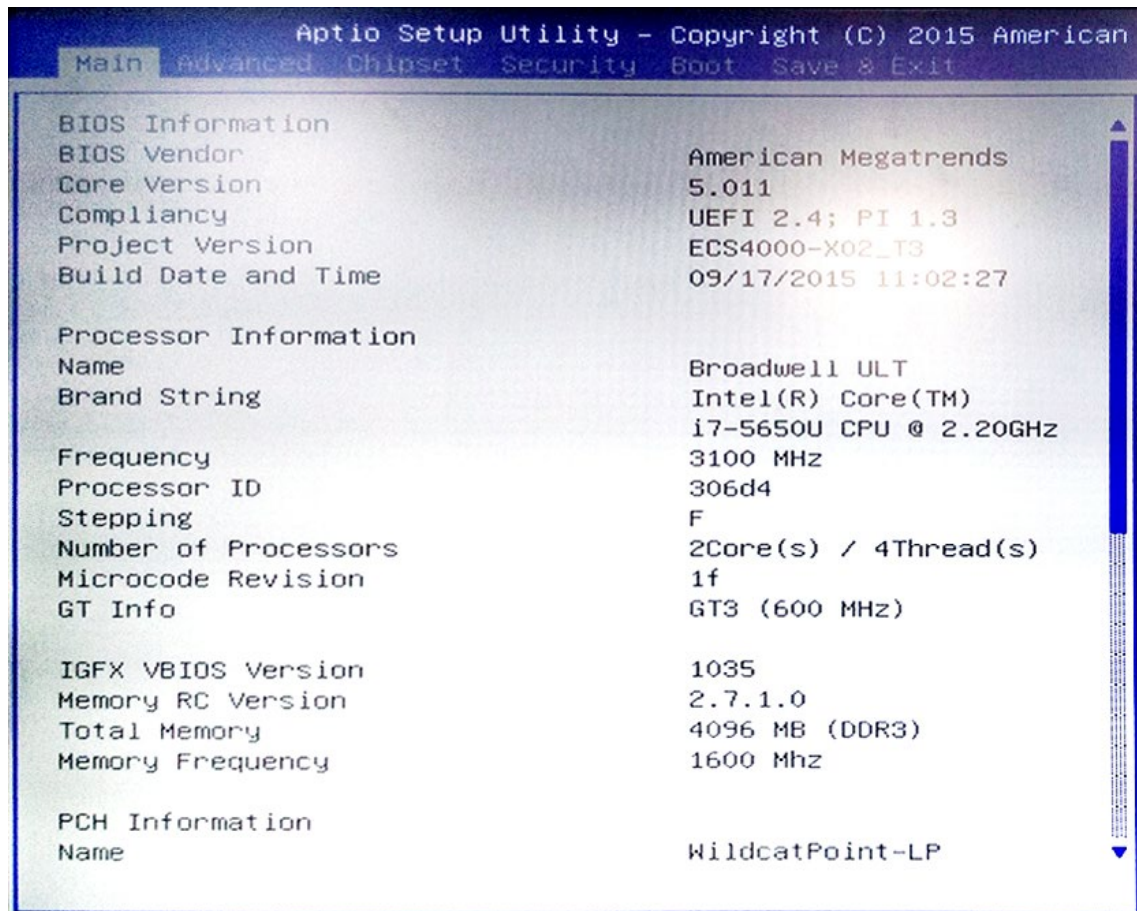

Figure 4 2: BIOS Main screen

4.2.1 BIOS Main Menu

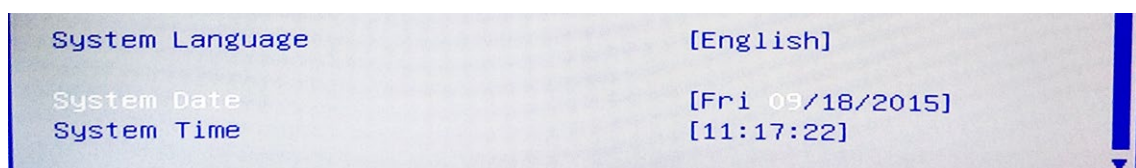

Figure 4-2-1: BIOS Main screen

System Time/ Date

Press "TAB" key to switch sub-items of value .Then press "+" key or "-" key number key for modify value.

In this page, you could make sure CPU type and DRAM type that you installed into this system.

4.3 Advanced Function

4.3.1 ACPI Setting

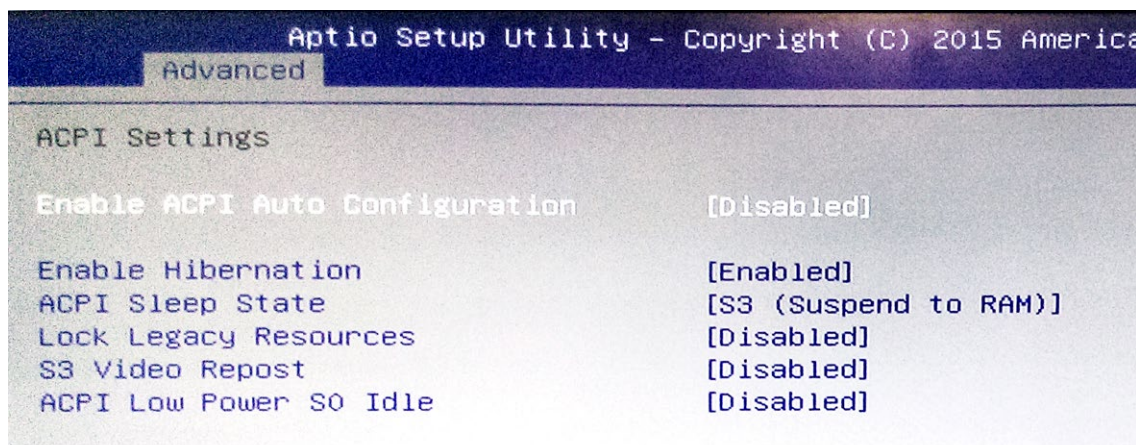

Figure 4-3-1: ACPI Setting setup screen

Enable ACPI Auto Configuration

This system support ACPI function as auto process. You should Enable/ Disable that depend as your OS.

Enable Hibernation

It is able to use Hibernate function if OS support. But some OS may not be effective with this function.

4.3.2 CPU Configuration

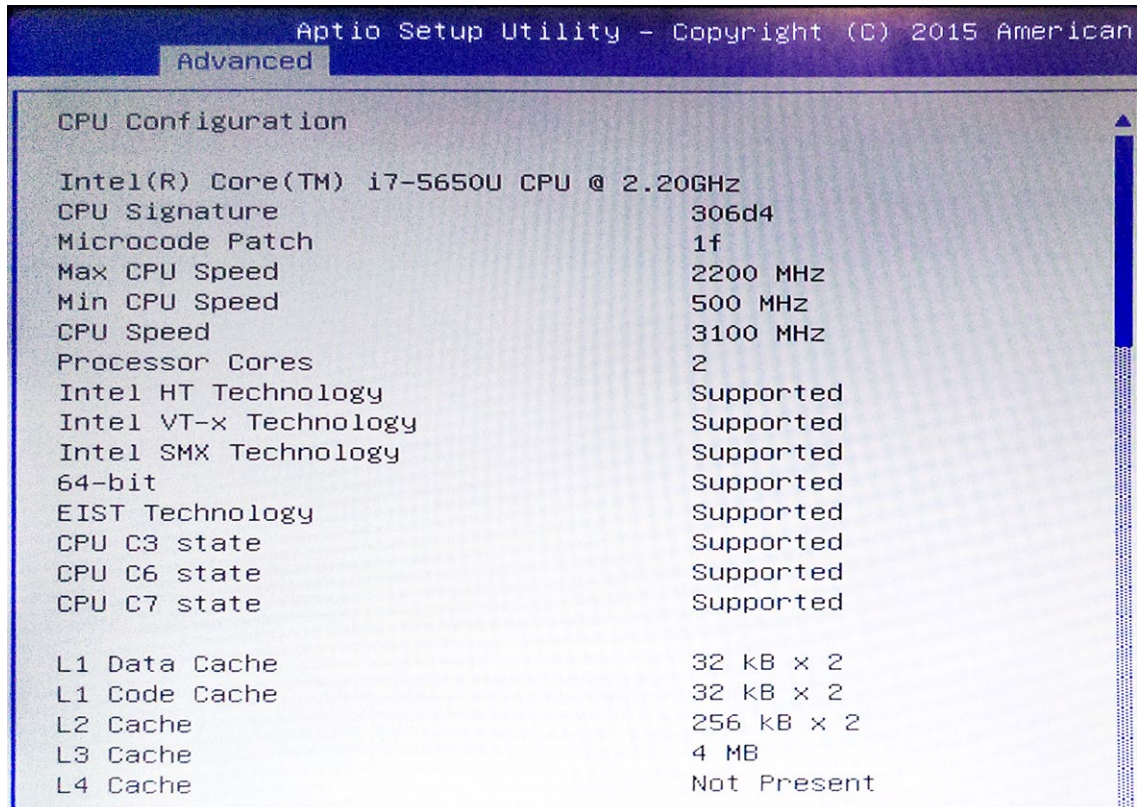

Figure 4-3-2: CPU Configuration setup screen

Intel Virtualization Technology

This for Virtualization Application or platform usage, when enabled, a VMM can utilize the additional hardware capabilities provided by Vanderpool Technology.

4.3.3 SATA Configuration

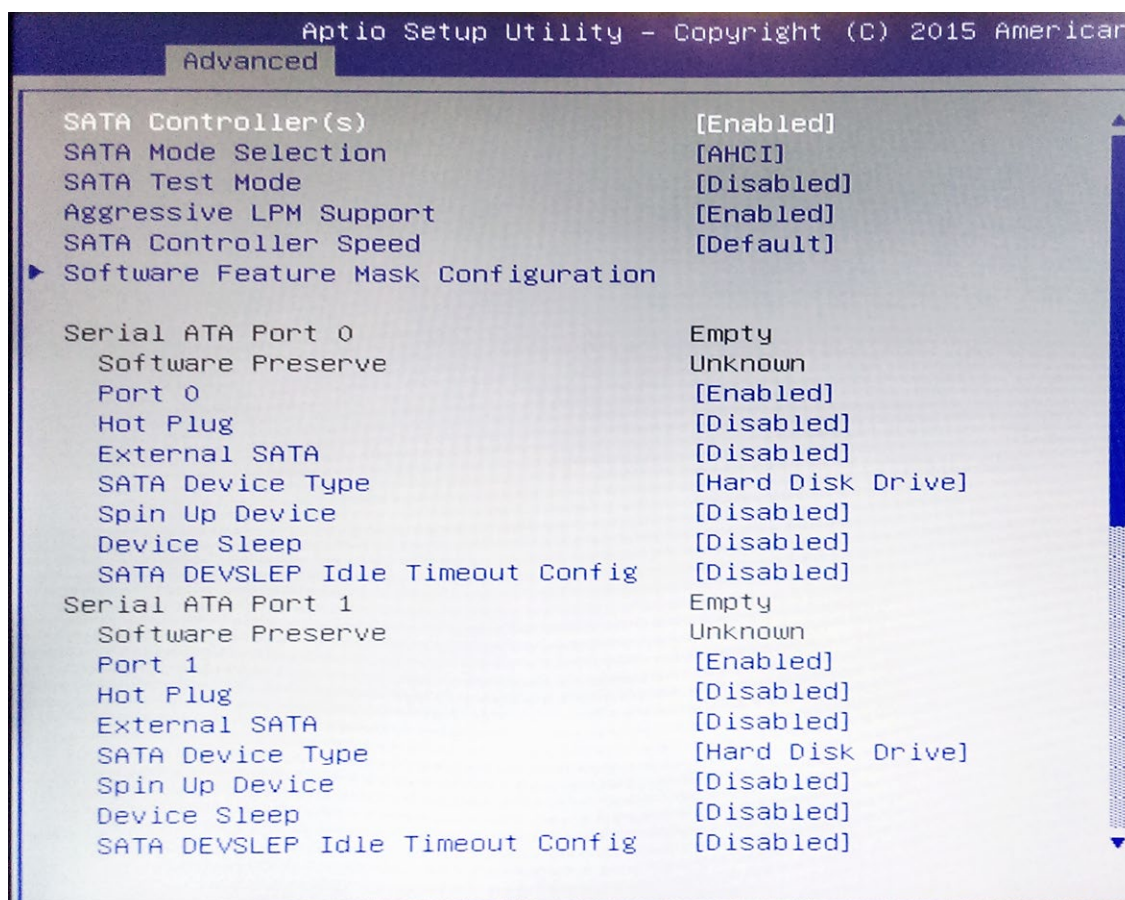

Figure 4-3-3 : SATA Configuration setup screen

SATA Controller(s)

Enables or Disables integrate SATA controller for storage devices.

SATA Mode Selection

Determines how the SATA transfer mode for operate. Here have three option for choice [IDE] / [AHCI] / [RAID]. For the RAID mode operate, please see appendix E. for detail information.

Serial ATA Port 0 to Port 3

This system offers 4 SATA port for connection SATA device.

4.3.4 AMT Configuration

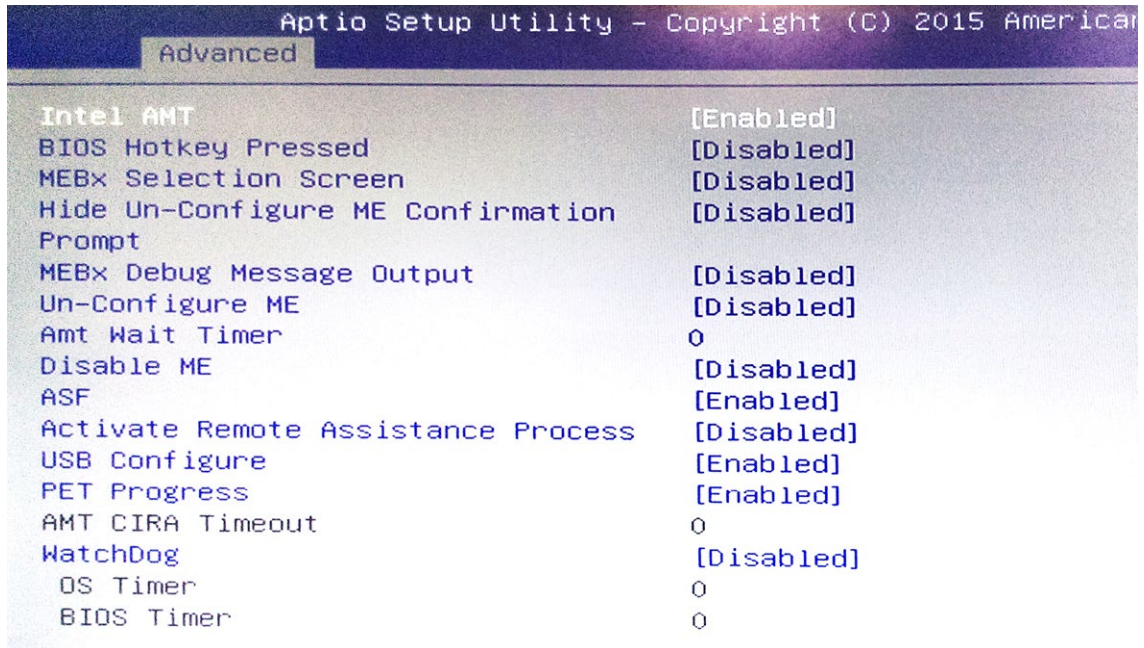

Figure 4-3-4: AMT Setup screen

Intel AMT

Enables or Disables Intel® Active Management Technology BIOS extension. This option just controls the BIOS extension executes.

4.3.5 Serial Port 1 Configuration

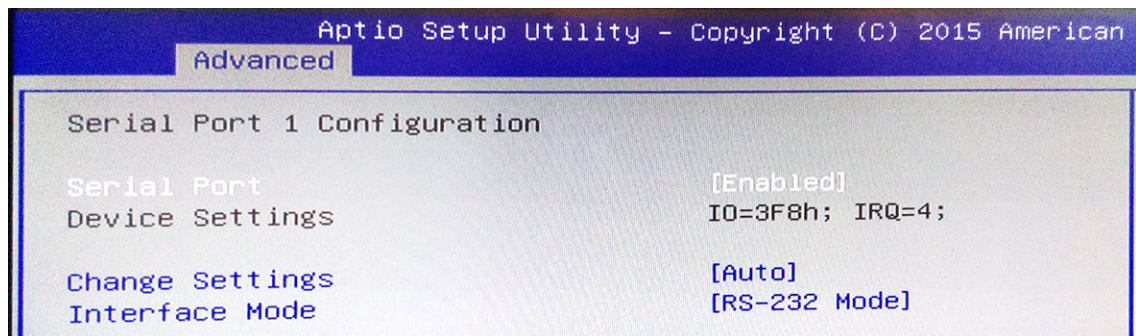

Figure 4-3-5 : Serial Port 1 Setup screen

Serial Port

Enable or Disable Serial Port.

Device Setting

Current IO address and interrupt resource of Serial Port.

Change Settings

Select another device setting.
There are 6 options as follow :

- Auto
- IO=3F8h; IRQ=4;
- IO=3F8h; IRQ=3,4,12;
- IO=2F8h; IRQ=3,4,12;
- IO=3E8h; IRQ=3,4,12;
- IO=2E8h; IRQ=3,4,12;

Interface Mode

There are 3 options as follow :

- RS-232 Mode
- RS-422 Mode
- RS-485 Mode

4.3.6 Serial Port 2 Configuration

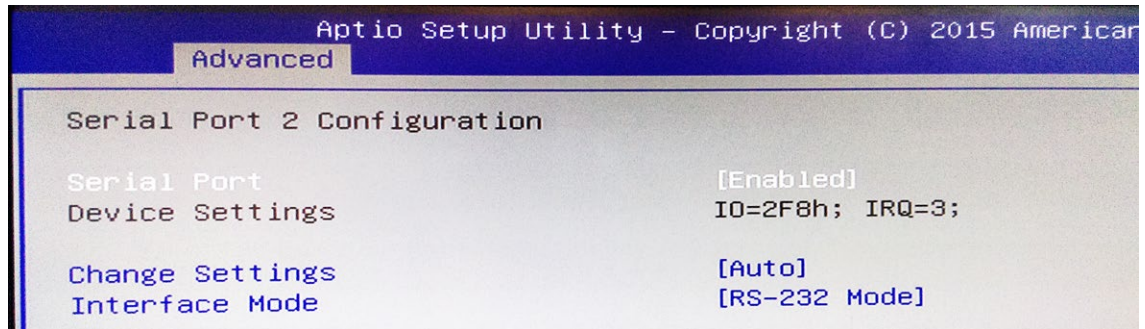

Figure 4-3-6 : Serial Port 2 Setup screen

Serial Port

Enable or Disable Serial Port.

Device Setting

Current IO addresses and interrupts resource of Serial Port.

Change Settings

Select another device setting.

There are 6 options as follow :

- Auto
- IO=2F8h; IRQ=3;
- IO=3F8h; IRQ=3,4,12;
- IO=2F8h; IRQ=3,4,12;
- IO=3E8h; IRQ=3,4,12;
- IO=2E8h; IRQ=3,4,12;

Interface Mode

There are 3 options as follow :

- RS-232 Mode
- RS-422 Mode
- RS-485 Mode

4.3.7 Serial Port 3 Configuration

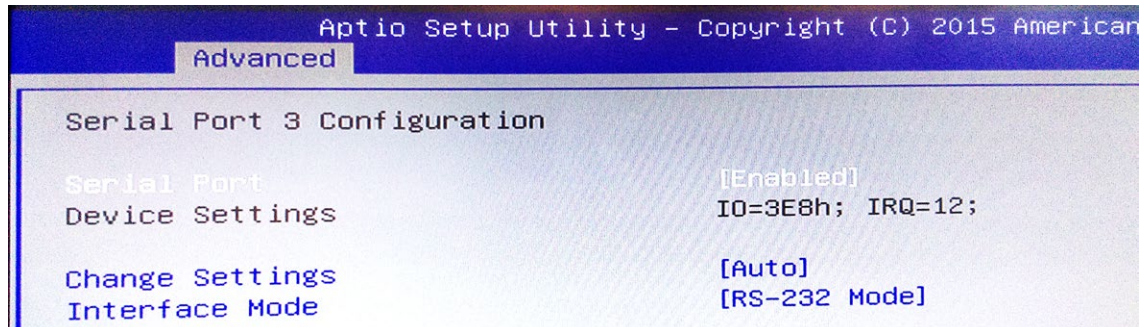

Figure 4-3-7 : Serial Port 3 Setup screen

Serial Port

Enable or Disable Serial Port.

Device Setting

Current IO address and interrupt resource of Serial Port.

Change Settings

Select another device setting.

There are 6 options as follow :

- Auto
- IO=3E8h; IRQ=12;
- IO=3E8h; IRQ=3,4,12;
- IO=2E8h; IRQ=3,4,12;
- IO=2F0h; IRQ=3,4,12;
- IO=2E0h; IRQ=3,4,12;

Interface Mode

There are 3 options as follow :

- RS-232 Mode
- RS-422 Mode
- RS-485 Mode

4.3.8 Serial Port 4 Configuration

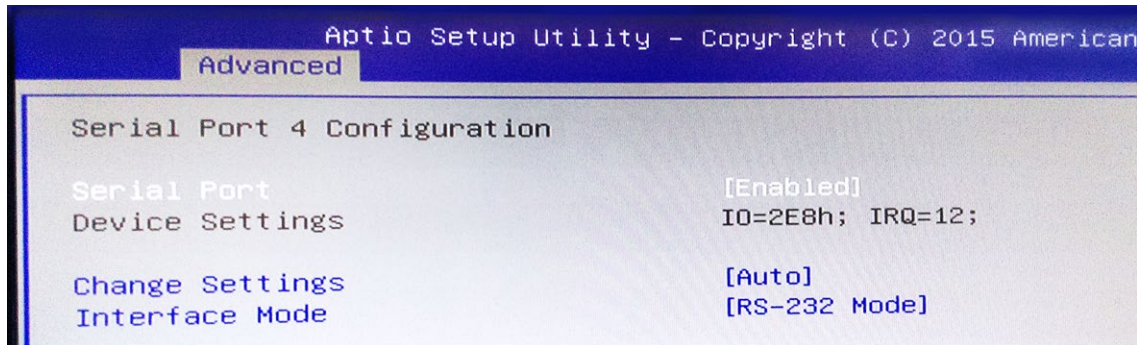

Figure 4-3-8 : Serial Port 4 Setup screen

Serial Port

Enable or Disable Serial Port.

Device Setting

Current IO address and interrupt resource of Serial Port.

Change Settings

Select another device setting.

There are 6 options as follow :

- Auto
- IO=2E8h; IRQ=12;
- IO=3E8h; IRQ=3,4,12;
- IO=2E8h; IRQ=3,4,12;
- IO=2F0h; IRQ=3,4,12;
- IO=2E0h; IRQ=3,4,12;

Interface Mode

There are 3 options as follow :

- RS-232 Mode
- RS-422 Mode
- RS-485 Mode

4.4 Chipset Function

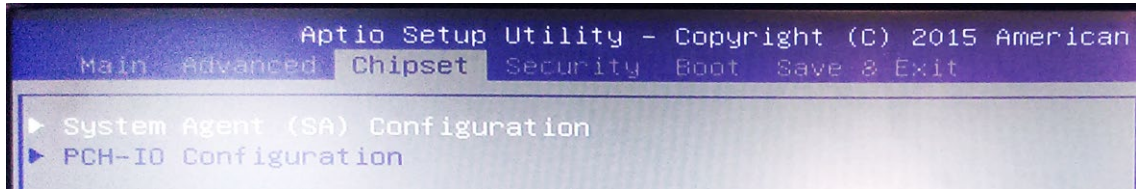

Figure 4-4: Chipset Function Setup screen

4.4.1 WOL Configuration

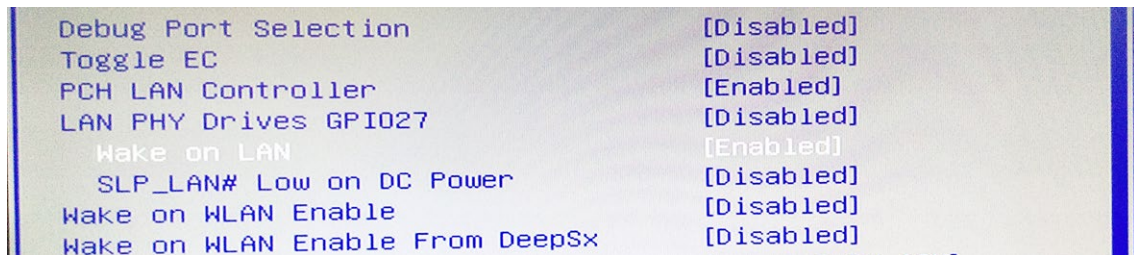

Figure 4-4-1 : Network Setup screen

PCH LAN Controller

Enable or Disable on board network device.

Wake on LAN

Enable or Disable integrated LAN to wake the system.
This function also can active by O.S.

4.5 Boot Function

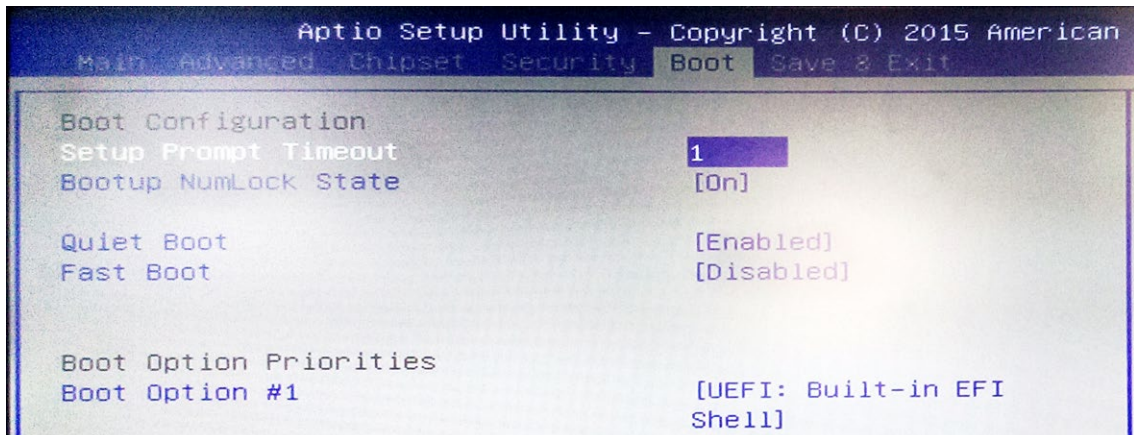

Figure 4-5: Boot function Setup screen

4.5.1 Boot Option



Figure 4-5-1 Boot Option Setup screen

Boot option

When you press "Enter", you can select which device you would like to boot.

A

APPENDIX A : ISOLATED DIO GUIDE

A.1 I/O Pin Definition

I/O Pin	Base Adr	Usage
GPIO 10~17	0xA00	CN16-GPIO
GPIO 20~27	0xA01	DIO Output
GPIO 30~37	0xA02	-----
GPIO 40~47	0xA03	-----
GPIO 50~57	0xA04	DIO Input
GPIO 60~67	0xA05	CN16-GPIO

A.2 Function Description

The E&Q Ę Ę offers a 16-bit DIO (8-DI/ 8-DO) 20-pin terminal block connector. Each bit of DI and DO equipped with a photo-coupler for isolated protection. All I/O pins are fixed by Hardware design and cannot change in/out direction in runtime process. The definition is listed as follows:

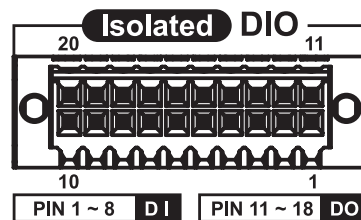

Pin No.	Definition	Description	Pin No.	Definition	Description
1	EXT_IN0	GPIO Input 0	11	EXT_OUT0	GPIO Output 0
2	EXT_IN1	GPIO Input 1	12	EXT_OUT1	GPIO Output 1
3	EXT_IN2	GPIO Input 2	13	EXT_OUT2	GPIO Output 2
4	EXT_IN3	GPIO Input 3	14	EXT_OUT3	GPIO Output 3
5	EXT_IN4	GPIO Input 4	15	EXT_OUT4	GPIO Output 4

6	EXT_IN5	GPIO Input 5	16	EXT_OUT5	GPIO Output 5
7	EXT_IN6	GPIO Input 6	17	EXT_OUT6	GPIO Output 6
8	EXT_IN7	GPIO Input 7	18	EXT_OUT7	GPIO Output 7
9	DI_COM	GPIO COM	19	Reserved	NC
10	EGND	GPIO GND	20	E24V	External 24V DC

Signal Circuit of Input NPN

Digital GPIO input signal circuit in SINK mode (NPN) is illustrated as follow.

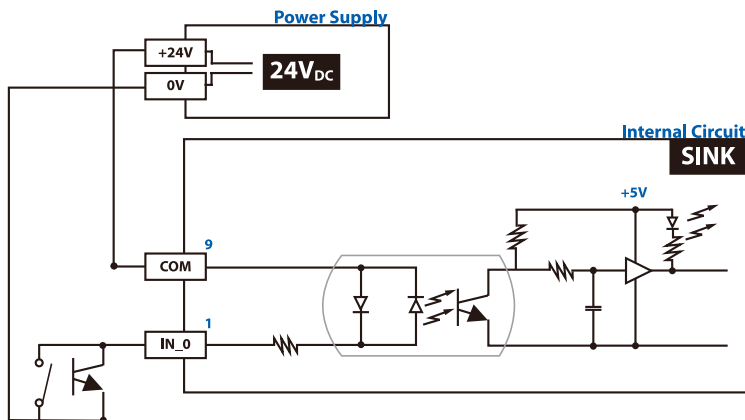

Signal Circuit of Input PNP

Digital GPIO input signal circuit in SOURCE mode (PNP) is illustrated as follow.

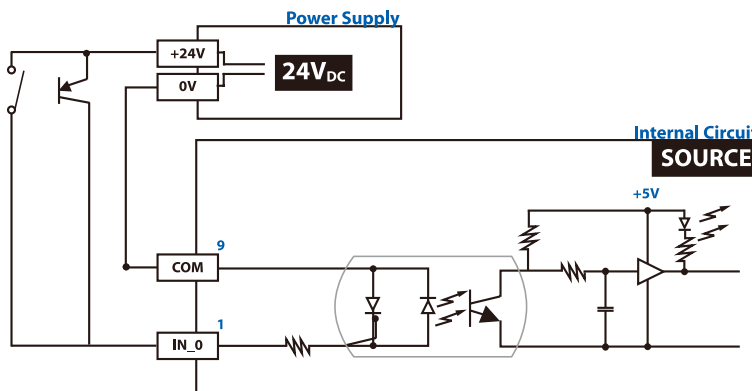

Signal Circuit of Output NPN

Digital GPIO output signal circuit in SINK mode (NPN) is illustrated as follow.

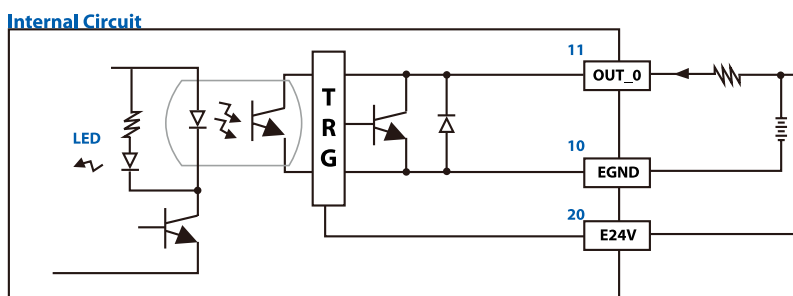

A.3 Software Package

There are 2 folders inside :

1. Driver Folder
2. DIO Demo Tool Folder

A.4 Driver Installing

Supports Windows 8.1 and Windows 7. Please do make sure your OS version before installing.

Please select “Add legacy hardware” on device management

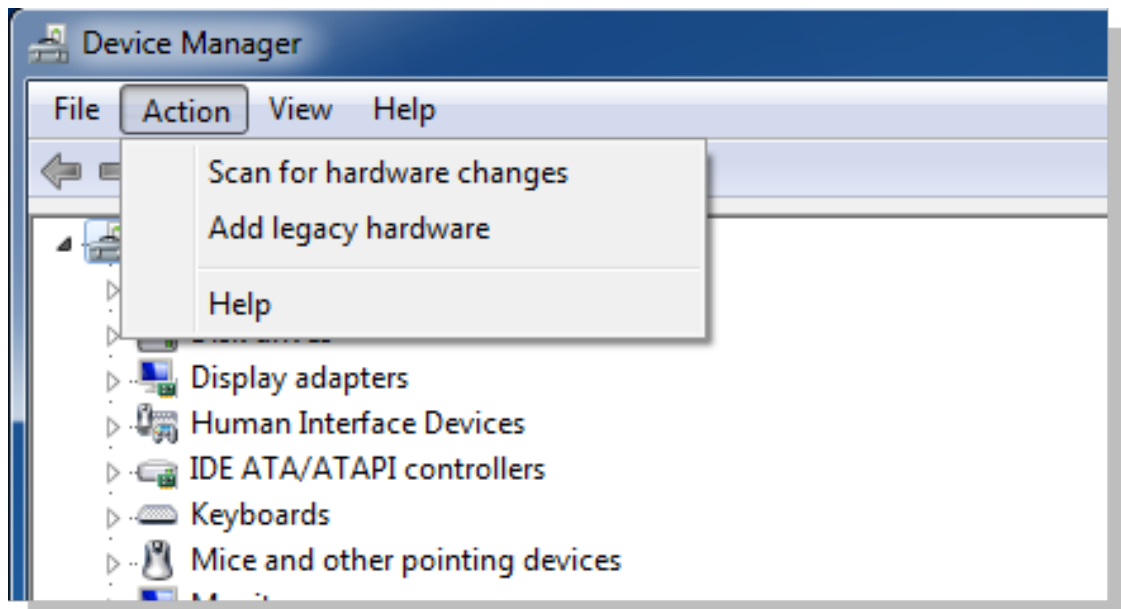

B

APPENDIX B : GPIO and WDT Functions

B.1 Function Description

The WDT are using internal Super I/O function. However, you must entry super I/O configuration mode to set it.

Super I/O special address port = 0x2E

Super I/O special data port = 0x2F

GPIO Logical device is 0x07

B.2 Entry Functions

1. Entry MB PnP Mode.

//write twice 0x87 value.

```
outportb(Super I/O special address port, 0x87);  
outportb(Super I/O special address port, 0x01);  
outportb(Super I/O special address port, 0x55);  
outportb(Super I/O special address port, 0x55);
```

2. Located on Logical Device 7(LOGIC_DEVICE_WDT)

//write 0x07 on Reg [0x07] , this setup must follow Step A. that can be workable.

```
outportb(Super I/O special address port, 0x07);  
outportb(Super I/O special data port, 0x07);
```

3. Config the WDT Register

```
outb(WDT_Config,SPECIAL_ADDRESS_PORT);  
outb(WDT_As_Second|WDT_Pin_PWRGD,SPECIAL_DATA_PORT);
```

4. Start WDT TimeOut Value

Here have 2 Byte for WDT timing count, MSB and LSB should be write the value separate.

<code>WDT_TimeOut_MSB,SPECIAL</code>	<code>WDT_TimeOut_LSB,SPECIAL</code>
--------------------------------------	--------------------------------------

```
outb(WDT_TimeOut_LSB,SPECIAL_ADDRESS_PORT);  
outb(WDT_TimeOutValue,SPECIAL_DATA_PORT);
```



APPENDIX C : Power Consumption

Echo-40F Power Consumption Testing :

Echo-40F			
Storage-CFast	N/A	Aux card 1	N/A
Storage-SATA 0	Transcend SSD370 SATA SSD 64GB	Aux card 2	N/A
Storage-SATA 1	N/A	Power Source	Chroma 62006P-100-25

Power Source :

CPU	RAM	Input Power	Standby Mode	
			Max Current	Max Consumption
i7-5650U	4GB X 2	06V	0.330A	01.98W
i7-5650U	4GB X 2	09V	0.227A	02.04W
i7-5650U	4GB X 2	12V	0.190A	02.28W
i7-5650U	4GB X 2	24V	0.215A	05.16W
i7-5650U	4GB X 2	28V	0.192A	05.38W
i7-5650U	4GB X 2	36V	0.137A	04.93W

CPU	Power-on and boot to Win7 64-bit			
	Idle Status : CPU usage less 3%		Run 100% CPU usage	
	Max Current	Max Consumption	Max Current	Max Consumption
i7-5650U	2.200A	13.20W	3.600A	21.60W
i7-5650U	1.430A	12.87W	2.250A	20.25W
i7-5650U	1.070A	12.84W	1.610A	19.32W
i7-5650U	0.610A	14.64W	0.900A	21.60W
i7-5650U	0.530A	14.84W	0.760A	21.28W
i7-5650U	0.430A	15.48W	0.610A	21.96W

For further support information, please visit www.CappuccinoPC.com

This document is released for reference purpose only.

All product offerings and specifications are subject to change without prior notice.

No part of this publication may be reproduced in any form or by any means, electric, photocopying, recording or otherwise, without prior authorization of the publisher.

The rights of all the brand names, product names and trademarks belong to their respective owners.

© Unicom Labs, INC. 2015. All rights reserved.